

Edge AI Applied Computing



IMB-600 Developer Kit

User Manual

Version 1.0

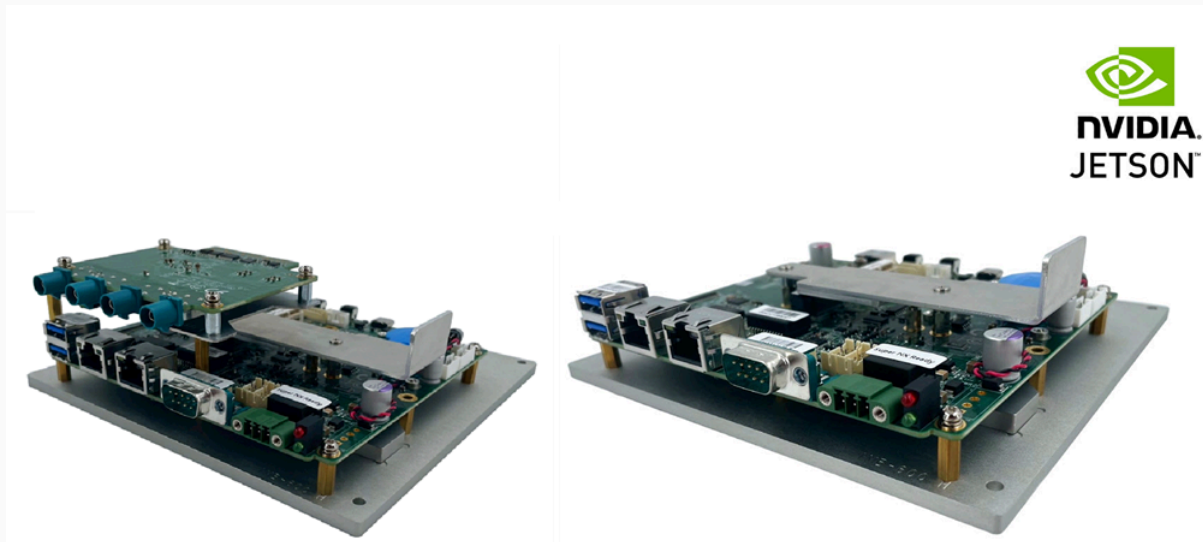

Revision History

Version	Date	Description of Changes
1.0	2026-05-15	Initial release.

Copyright

©2026 by SINTRONES® Technology Corp. All Rights Reserved.

No part of this publication may be reproduced, transcribed, stored in a retrieval system, translated into any language, or transmitted in any form or by any means such as electronic, mechanical, magnetic, optical, chemical, photocopy, manual, or otherwise, without prior written permission from SINTRONES® Technology Corp.

Other brands and product names used herein are for identification purposes only and may be trademarks of their respective owners.

Disclaimer

SINTRONES® Technology Corp. shall not be liable for any incidental or consequential damages resulting from the performance or use of this product.

SINTRONES® Technology Corp. makes no representation or warranty regarding the content of this manual. Information in this manual has been carefully checked for accuracy; however, no guarantee is given to the correctness of the contents. For continuing product improvement, SINTRONES® Technology Corp. reserves the right to revise the manual or make changes to the specifications of this product at any time without notice and obligation to any person or entity regarding such change. The information contained in this manual is provided for general use by customers.

Declaration of Conformity



The CE symbol on your product indicates that it complies with the European Union (EU) directives. A Certificate of Compliance is available by contacting Technical Support. This product has passed the CE test for environmental specifications when shielded cables are used for external wiring. We recommend the use of shielded cables.



This product has been tested and found to comply with the limits for a Class A device, according to Part 15 of the FCC Rules. These limits are designed to protect reasonably against harmful interference in a residential installation. This equipment generates, uses, and can radiate radio frequency energy and, if not installed and used by the manufacturer's instructions, may cause harmful interference to radio communications.

Trademarks

SINTRONES® is a registered trademark of SINTRONES® Technology Corp.

The terms HDMI, HDMI High-Definition Multimedia Interface, HDMI Trade dress and the HDMI Logos are trademarks or registered trademarks of HDMI Licensing Administrator, Inc.

All the trademarks, registrations, and brands mentioned herein are used for identification purposes only and may be trademarks and registered trademarks of their respective owners.

Safety Information

Read the following precautions before setting up a SINTRONES® Product.

Electrical Safety

- Disconnect the power cable from the electrical outlet to prevent shock hazards before relocating the system.
- When adding or removing devices to or from the system, ensure that the power cables for the devices are unplugged before the signal cables are connected. Disconnect all power cables from the existing system before adding a device.
- Seek professional assistance before using an adapter or extension cord. These devices could interrupt the grounding circuit.
- Before connecting or removing signal cables from the motherboard, ensure all power cables are unplugged.
- Ensure your power supply is set to the correct voltage in your area. If you are unsure of the voltage of your current electrical outlets, contact your local power company.
- If the power supply is broken, do not fix it by yourself. Contact a qualified service technician or your retailer.

Operation Safety

- Before installing the motherboard and adding devices, carefully read all the manuals in the package.
- Before using the product, ensure all cables are correctly connected and the power cables are not damaged. If you detect any damage, contact your dealer immediately.
- Keep paper clips, screws, and staples away from connectors, slots, sockets, and circuitry to avoid short circuits.
- Avoid dust, humidity, and temperature extremes. Please do not place the product in any area that may become wet.
- Place the product on a stable surface.
- Contact a qualified service technician or retailer if you encounter technical problems with the product.

Environmental Safety

- Use this product in environments with ambient temperatures between -25°C and 50°C.
- Do not leave this product in an environment where the storage temperature may be below -40°C or above 80°C. To prevent damage, the product must be used in a controlled environment.



CAUTION:

Incorrectly replacing the battery may damage this computer. Replace only with the same or equivalent recommended by SINTRONES® Technology Corp. Dispose of the used battery according to the manufacturer's instructions.

Technical Support

Please call or e-mail our customer service when you cannot fix the problems.



- TEL: +886-2-8228-0101
- FAX: +886-2-8228-0100
- E-mail: sales@sintrones.com

Contents

1. Introduction.....	7
1.1. Product Information.....	8
1.2. Product Photos.....	11
1.3. Mechanical Drawings.....	12
1.4. Package Contents.....	13
1.5. Power Consumption.....	17
2. Getting Started.....	18
2.1. SoM Information.....	19
2.1.1. Information about Jetson Modules.....	20
2.1.2. Configuring Power Mode for Jetson Modules.....	21
2.2. System Setup.....	22
2.2.1. Installing Expansion Modules.....	22
2.2.2. Installing a Nano SIM Card.....	29
2.2.3. Installing the GMSL-2 Deserializer Board.....	30
2.3. Booting the System.....	36
2.3.1. Wiring the Terminal Block.....	36
2.3.2. Powering On the System by Ignition Switch.....	36
2.3.3. Powering On the System by Button.....	37
2.4. Initial Login.....	37
3. External I/O Ports.....	38
3.1. Front I/O.....	39
3.2. Rear I/O.....	41
3.3. Specifications of External I/O Ports.....	43
3.3.1. USB 3.2 Port.....	43
3.3.2. COM Port.....	43
3.3.3. DC-IN Port (3-Pin Terminal Block).....	44
3.3.4. USB Type-C Port.....	44
3.3.5. HDMI® Port.....	45
4. Expansion.....	46
4.1. Top View of Mainboard.....	47
4.2. Bottom View of Mainboard.....	48

4.3. Specifications of Expansion Slots/Connectors.....	49
4.3.1. M.2 Key B Slot.....	49
4.3.2. M.2 Key E Slot.....	50
4.3.3. M.2 Key M Slot.....	52
4.3.4. Mini PCIe Connector.....	53
4.3.5. DIO JST Connector.....	55
4.3.6. CAN Bus JST Connector.....	55
4.3.7. DSU JST Connector.....	56
5. Software.....	57
5.1. Customizing BSP Kernel Source Build.....	58
5.1.1. Prerequisites for Host Environment Setup.....	58
5.1.2. Host Environment Setup.....	58
5.1.3. Docker Setup and Container Access.....	59
5.1.4. Building BSP Kernel Source Code.....	60
5.1.5. Setting the IMB-600 in Recovery Mode.....	61
5.1.6. BSP Flashing and System Configuration.....	61
5.2. System Configuration.....	65
5.2.1. Smart Power Management Settings.....	65
5.2.2. Commands for COM Port (RS-232/422/485 Configuration).....	68
5.2.3. CAN FD Configuration.....	69
5.2.4. DIO Configuration.....	70
5.2.5. (Optional) Setting the GMSL Camera.....	72

1. Introduction

The IMB-600 features a purpose-built carrier board with preinstalled NVIDIA® Jetson™ Orin AI module and rich I/O connectivity, along with a Mini-ITX thermal plate that provides optimal heat dissipation, aimed at empowering individuals and organizations to develop and deploy scalable, reliable edge AI applications.

The **basic version of the IMB-600 Developer Kit** includes an industrially designed carrier board where an NVIDIA® Jetson™ Orin System-on-Module (SoM) is installed, an industrial grade NVMe SSD preloaded with the Board Support Package (BSP), essential cables for streamlined system setup, and a 12V DC adapter.

To meet the need for high-resolution video transmission with ultra-low latency, the **advanced version** features the **addition of a GMSL-2 deserializer board (VDB-100/101GDS4 kit)**, enabling developers to test and seamlessly integrate industrial-grade GMSL camera technology into AI-driven applications.

This chapter introduces SINTRONES® IMB-600 and gives an overview of its product details.

Topics in this chapter include:

- [Product Information \(on page 8\)](#)
- [Product Photos \(on page 11\)](#)
- [Mechanical Drawings \(on page 12\)](#)
- [Package Contents \(on page 13\)](#)
- [Power Consumption \(on page 17\)](#)

1.1. Product Information

Table 1-1 Specifications

System	Power
Module <ul style="list-style-type: none"> NVIDIA® Jetson Orin™ NX 16GB (1024 CUDA cores + 8-core ARM Cortex-A78AE CPU + 16 GB LPDDR5) NVIDIA® Jetson Orin™ NX 8GB (1024 CUDA cores + 6-core ARM Cortex-A78AE CPU + 8 GB LPDDR5) Network <ul style="list-style-type: none"> 1 x Intel® 2.5GbE, 1 x GbE (Integrated in SoM) Security <ul style="list-style-type: none"> Platform Security Controller (PSC), Security Engine (SE) Watchdog <ul style="list-style-type: none"> Auto reset for unresponsive system 	Power Input <ul style="list-style-type: none"> DC 9-60V (nominal power input DC 12V/24V/48V) via 3-pin terminal block Power Protection <ul style="list-style-type: none"> OCP, OVP, surge protection, reversed polarity protection Power Management <ul style="list-style-type: none"> Smart Power Management RTC Battery <ul style="list-style-type: none"> High-capacity coin cell battery for RTC
Interface	Software
Video <ul style="list-style-type: none"> 1 x HDMI® Type-A Audio <ul style="list-style-type: none"> 1 x HD audio output from the HDMI® Ethernet <ul style="list-style-type: none"> 2 x RJ-45 Camera <ul style="list-style-type: none"> 1 x Eight lanes MIPI CSI-2 D-PHY 2.1 via 50-pin FFC CAN <ul style="list-style-type: none"> 1 x CAN FD via DB-9 USB <ul style="list-style-type: none"> 2 x USB 3.2 DIO <ul style="list-style-type: none"> 4 x DI, 4 x DO (DC 12V/100mA) via DB-9 COM <ul style="list-style-type: none"> 1 x RS-232/422/485 via DB-9 Mgmt. Port <ul style="list-style-type: none"> 1 x USB Type-C for system recovery only (device only) SIM Card <ul style="list-style-type: none"> 1 x Nano SIM card slot 	Operating System <ul style="list-style-type: none"> NVIDIA® JetPack 6.2 or above (Jetson Linux and NVIDIA® development tools included)
	Environmental
	Operating Temp. <ul style="list-style-type: none"> -25°C ~ 50°C (-13°F ~ 122°F)* with 0.6 m/s airflow (IMB-600-ONX16 DEV KIT model) <small>*Measured at non-MAXN/MAXN SUPER high-power mode</small> Storage Temp. <ul style="list-style-type: none"> -40°C ~ 80°C (-40°F ~ 176°F) Relative Humidity <ul style="list-style-type: none"> 10% ~ 90% RH (non-condensing)
	Certification / Standard
	<ul style="list-style-type: none"> CE, FCC Class A, UKCA
	Mechanical
	Construction <ul style="list-style-type: none"> Aluminum alloy Mounting <ul style="list-style-type: none"> Mini-ITX standard mounting holes Weight <ul style="list-style-type: none"> 0.9 kg (1.98 lb) Dimensions (L x W x H) <ul style="list-style-type: none"> IMB-600: 170 x 170 x 35.44 mm (6.7 x 6.7 x 1.4 in.) IMB-600 + VDB-100/101GDS4: 170 x 170 x 59.4 mm (6.7 x 6.7 x 2.34 in.)
Internal Expansion	
M.2 <ul style="list-style-type: none"> 1 x M.2 3042/3052 Key B for WWAN (USB 3.2) w/ Nano SIM support 1 x M.2 2230 Key E for Wi-Fi/BT (PCIe and USB 2.0) Mini PCIe <ul style="list-style-type: none"> 1 x Mini PCIe (full-size w/ USB 2.0) 	
Storage	
Type <ul style="list-style-type: none"> 1 x M.2 2280 Key M for NVMe SSD (Pre-installed system BSP) 	

Table 1-2 Ordering Information

Model Number	IBOX-600-ONX16 DEV KIT	IMB-600 Carrier Board with Jetson Orin NX 16GB SoM*
	IBOX-600-ONX8 DEV KIT	IMB-600 Carrier Board with Jetson Orin NX 8GB SoM*
	VDB-100GDS4 DEV KIT	4-Port GMSL-2 Deserializer Board - Analog Devices MAX96724
	VDB-101GDS4 DEV KIT	4-Port GMSL-2 Deserializer Board - Analog Devices MAX9296A
	SSD 480 GB**	NVMe SSD 480GB w/ system BSP pre-installed
	SSD 240 GB**	NVMe SSD 240GB w/ system BSP pre-installed
	BBU-2300V2	Battery Backup Unit 2350 mAh
Description	NVIDIA® Jetson Orin™ NX Developer Kit	

*According to NVIDIA® website, the Jetson Orin™ SoM is available through January 2032.

**Mandatory accessory. NVMe SSD performance varies by different storage capacities.

Table 1-3 Optional Accessories

Wi-Fi	M.2 2230 Wi-Fi Module
WWAN	M.2 3042/3052 WWAN Modem
GNSS	Mini PCIe GNSS module
Camera	SINTRONES® VCM-1020G2 Series: <ul style="list-style-type: none">• Sony IMX390 2MP, 63.9°• GMSL-2, 63.9°/120°/186°
	oToBrite - otoCAM223

**Note:**

All items listed in the Optional Accessories table are sold separately.

1.2. Product Photos

Figure 1-1 Front View of IMB-600 Developer Kit

IMB-600 Carrier Board

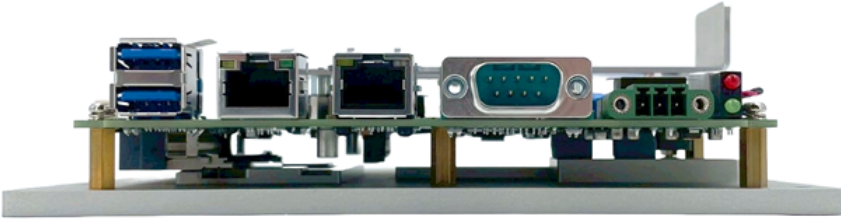

IMB-600 Carrier Board + GMSL-2 Deserializer Board

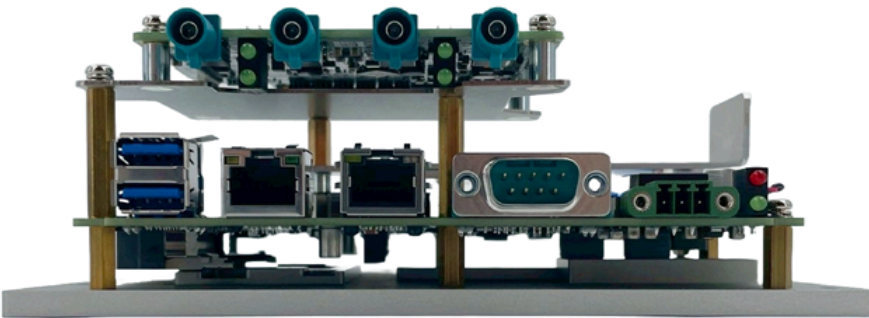
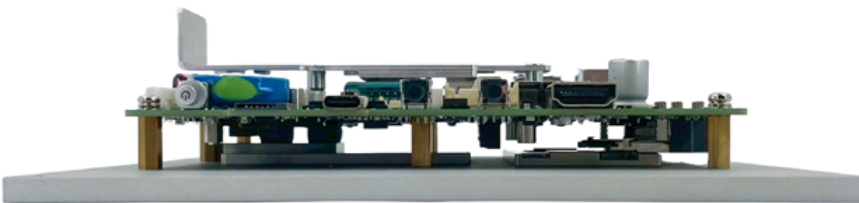
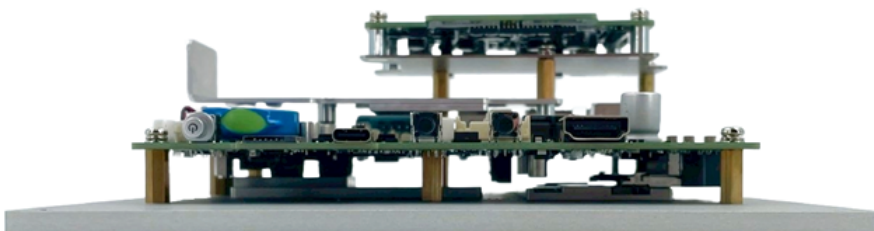

Figure 1-2 Rear View of IMB-600 Developer Kit

IMB-600 Carrier Board



IMB-600 Carrier Board + GMSL-2 Deserializer Board



1.3. Mechanical Drawings

The following mechanical drawings include the **IMB-600 carrier board** and the optional **GMSL-2 deserializer board**.



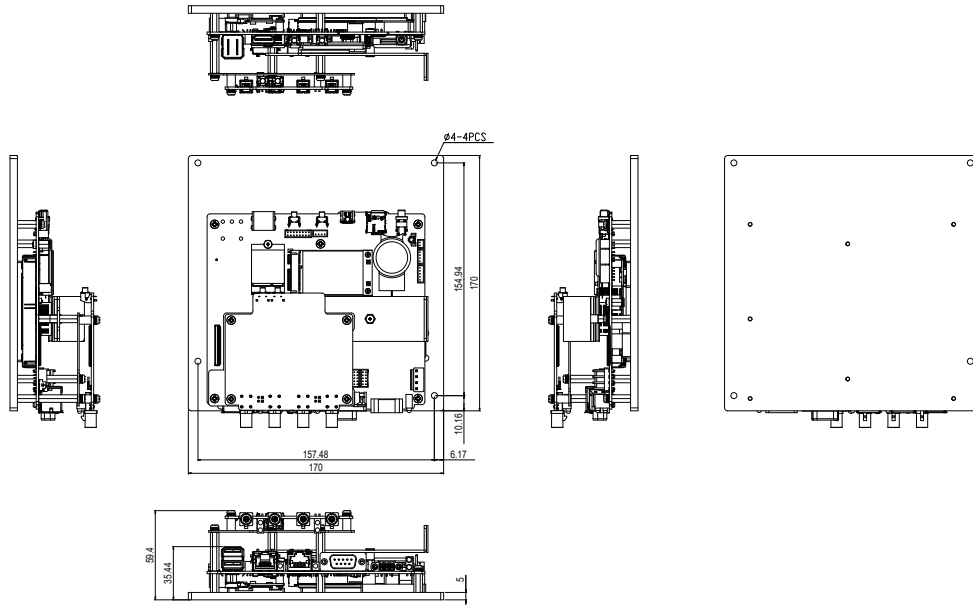

Unit : mm















1.4. Package Contents

See the following list to check if it matches your product package contents. Please contact SINTRONES® sales representatives or our sales partners if any of the items is missing.

Table 1-4 Package Contents for IMB-600 Developer Kit & Optional VDB-100/101GDS4 Kit

Item	Photo	Quantity	Description
IMB-600 Carrier Board	See Product Photos (on page 11)	1	The carrier board with NVIDIA® Jetson Orin™ NX 16GB/8GB SoM.
Power adapter (12V/5A 60W) for IMB-600		1	Used to convert AC voltage to DC voltage for the IMB-600.
Accessory Bag 1 for IMB-600 Standard Package	Thermal pad (27x34x1.5T mm) 	1	Used to transfer heat from an installed M.2 3042 or 3052 module.
	M.2 WWAN heatsink (Type 15) 	1	Used to transfer heat from an installed M.2 3042 or 3052 module.
	Screw I (Type M2.5x10L) 	1	Used to fasten a heatsink for an M.2 3042 or 3052 module.
	Standoff screw (H12D5) 	1	Used to fasten a heatsink for an M.2 3042 or 3052 module and serve as the mounting screw-hole for the optional GMSL-2 deserializer board.
	Hex standoff screw (H75D50)	2	Served as the mounting screw-holes for the heatsink for an M.2 3042 or 3052 module.

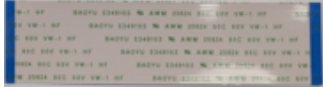
Item	Photo	Quantity	Description
			
	Screw I (Type M2.5x5L) 	2	Used to fasten an M.2 module.
	Screw I (Type M2x5L ISO) 	2	Used to fasten an mini PCIe card.
	Hex standoff screw 	8	Used to secure the GPIO, CAN, and COM connectors to a chassis or serve as threaded points for interconnecting with other connectors.
	Round head screw (P3x8L) 	4	Used to mount the thermal plate (with IMB-600 carrier board on top of it).
Accessory Bag 2 for IMB-600 Standard Package	GPIO cable 	1	Used to connect the IMB-600 to external peripherals for DIO signal control.
	CAN bus cable 	1	Used to connect the IMB-600 to external peripherals for CAN bus signal control.
	COM cable 	1	Used to connect the IMB-600 to external peripherals for RS-232/422/485 signal control.

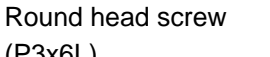
Item	Photo	Quantity	Description
	Power terminal block 	1	Used to convert AC voltage to DC voltage for the IMB-600, providing a power plug for the adapter and an ignition switch.
(Optional) VDB-100/101GDS4 Kit*			
GMSL-2 Deserializer Board	VDB-100GDS4 PCBA 	1	The PCBA with 4-port GMSL-2 deserializer (ADI MAX96724).
	VDB-101GDS4 PCBA 		The PCBA with 4-port GMSL-2 deserializer (ADI MAX9296A).
Accessory Bags for VDB-100/101GDS4 Kit	Flexible Flat Cable (FFC) 	1	Used for installing the VDB-100/101GDS4 PCBA on the IMB-600
	Adhesive Tape (Length: 3 cm) 	2	
	Standoff screw (H26D5) 	3	
	Round head screw (P3x6L) 	5	

Item	Photo	Quantity	Description
	 PCBA Bracket 	1	
FAKRA Cable		2	Used to connect the GMSL cameras to the camera ports on the VDB-100/101GDS4 PCBA.



Note:

The VDB-100/101GDS4 DEV KIT are sold separately.

1.5. Power Consumption

See the following table as the power consumption of IMB-600.

Table 1-5 IBOX-600-ONX16 DEV KIT

Mode	Input Voltage				
	9V	12V	24V	48V	60V
25W (SoM Power Mode)	35.55W	34.32W	34.08W	35.04W	37.80W
Idle	11.7W	12.72W	12.96W	14.88W	16.80W
Standby	1.80W	2.52W	4.08W	6.24W	7.20W

Table 1-6 IBOX-600-ONX8 DEV KIT

Mode	Input Voltage				
	9V	12V	24V	48V	60V
20W (SoM Power Mode)	30.24W	30.48W	30.24W	34.08W	34.80W
Idle	9.72W	9.24W	10.80W	12.96W	14.40W
Standby	2.25W	2.64W	3.12W	5.28W	6.00W

2. Getting Started

Topics in this chapter include:

- [SoM Information \(on page 19\)](#)
- [System Setup \(on page 22\)](#)
- [Booting the System \(on page 36\)](#)
- [Initial Login \(on page 37\)](#)

2.1. SoM Information

The pre-installed NVIDIA® Jetson System on Module (SoM) is located on the bottom side of the IMB-600. The NVIDIA® Jetson module integrates CPU, GPU, and memory with pre-installed JetPack developer tools. Please refer to [Information about Jetson Modules \(on page 20\)](#) for more information.

**Important:**

DO NOT remove the pre-installed SoM or install an empty one without preparing any backup image in advance. It is suggested to consult SINTRONES technical support for replacement requirements for the Jetson SoM.

Figure 2-1 Location of the SoM on the Bottom Side of IMB-600

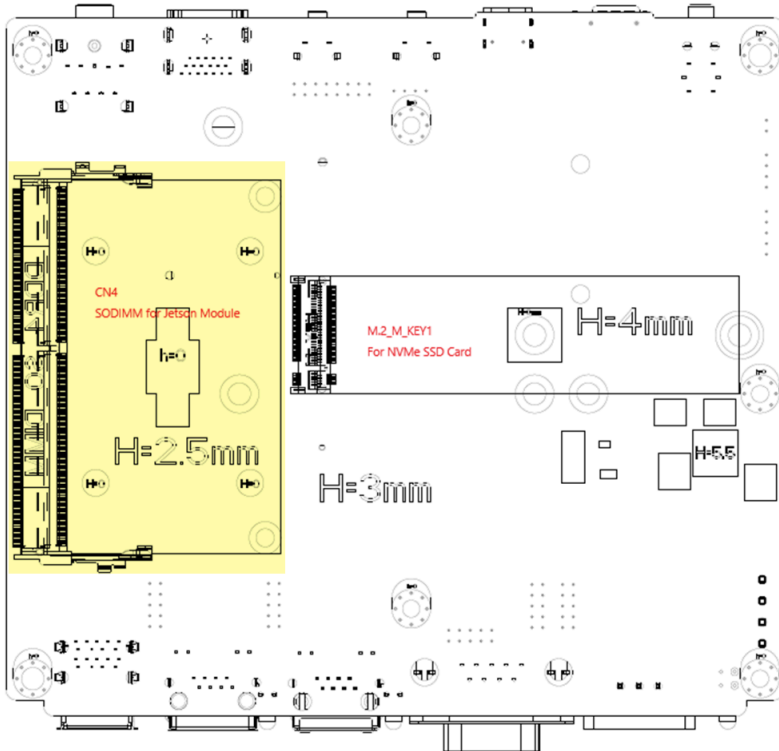

2.1.1. Information about Jetson Modules

Table 2-1 NVIDIA® Jetson Orin™ NX Modules Pre-installed in IMB-600

Series	Jetson Orin NX Series	
Model	Jetson Orin NX 16GB	Jetson Orin NX 8GB
GPU	1024-core NVIDIA® Ampere architecture GPU with 32 Tensor Cores	
CPU Frequency	2.0 GHz	
Power Consumption	25W	20W
CPU	8-core Arm® Cortex® - A78AE	6-core Arm® Cortex® - A78AE
DL Accelerator	2 x NVDLA v2	1 x NVDLA v2
Vision Accelerator	1 x PVA v2	
Memory	16GB 128-bit LPDDR5	8GB 128-bit LPDDR5
Storage	Supports external NVMe SSD (Pre-installed in system with BSP)	

2.1.2. Configuring Power Mode for Jetson Modules

NVIDIA® Jetson modules support multiple predefined power budgets, allowing users to select the **Power Mode** that best fits their needs via the Jetson Linux GUI or CLI.

By default, SINTRONES® system is not configured at the unconstrained power mode (MAXN or MAXN SUPER*). The system operating temperature range is validated under **non-MAXN/MAXN SUPER** high-power mode.

Therefore, when the system runs in **MAXN** or **MAXN SUPER** mode, the system's maximum operating temperature may be reduced. It is **NOT recommended to run prolonged operation under heavy workloads** in these modes.

**Note:**

*The MAXN SUPER mode is only available in JetPack 6.2 for Jetson Orin Nano and Orin NX modules.

For detailed instructions on configuring power modes to optimize efficiency, please refer to the [official NVIDIA® documentation](#).

Examples of **power mode selection menus** for Jetson Orin NX 16GB and Jetson AGX Orin 32GB:

Jetson Orin NX 16GB

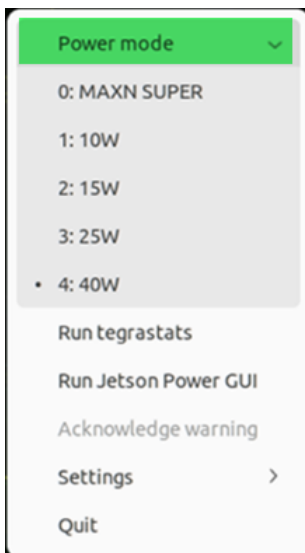

Jetson AGX Orin 32GB

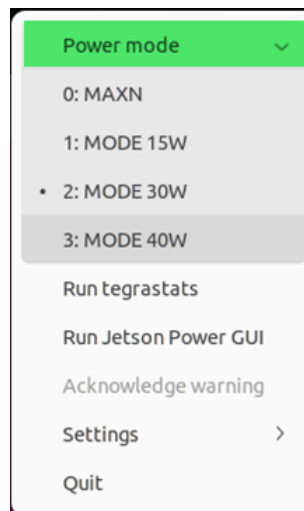

2.2. System Setup

This section provides instructions on how to install **expansion modules** and a **Nano SIM card**, and the **optional GMSL-2 deserializer board** for the IMB-600.

You can also refer to [Expansion \(on page 46\)](#) for more details such as pin definitions about the internal slots or JST connectors used for expansion purpose.

Before you start the installation, check the following safety instructions:



Important:

- Ensure the IMB-600 is not connected to any power source such as a power adapter or a battery.
- Prior to installing any modules on the mainboard, always touch an unpainted and grounded metal object or wear a grounded anti-static wrist strap to prevent electrostatic discharge (ESD).

2.2.1. Installing Expansion Modules

This section provides step-by-step instructions on how to install an:

- M.2 2280 SSD module
- M.2 3042/3052 WWAN module and its heatsink
- M.2 2230 WLAN module
- Mini PCIe expansion module

See the following steps to start the installation:

2.2.1.1. Installing M.2 2280 SSD Module

An NVMe SSD is pre-installed on the IMB-600 carrier board before shipment. Since the M.2 2280 Key M slot for the NVMe SSD is located on the bottom side of the carrier board and requires preparing a backup image prior to replacement, it is strongly recommended to consult SINTRONES technical support for expansion requirements.



Important:

If replacement is necessary, **ensure a backup image is prepared** prior to removing the pre-installed SSD or installing an empty SSD.

The following instructions assume that the [SSD module \(on page 9\)](#) is purchased from SINTRONES®.

1. Load a backup image from the pre-installed SSD.
2. Power off the IMB-600 carrier board, then remove the seven screws from it.

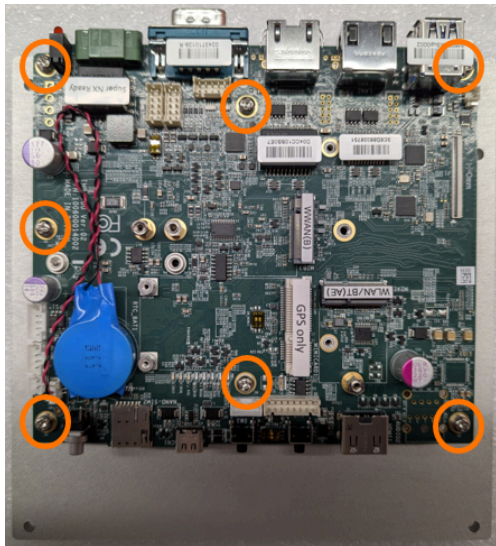

3. Detach the carrier board from the mini-ITX thermal plate and turn it over.

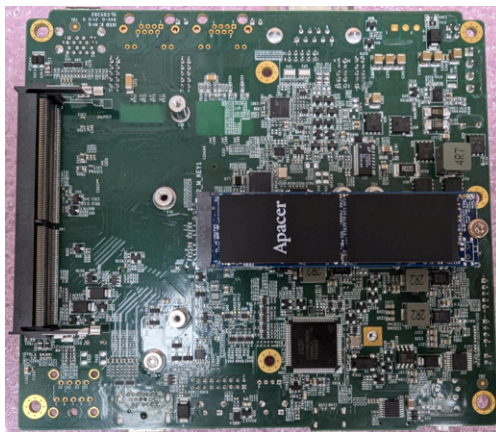

4. Locate the pre-installed NVMe SSD on the carrier board. **Ensure you prepare a backup image of the pre-installed NVMe SSD before proceeding to the next step.**

5. Remove the M2.5x5L screw at the end of the drive, allowing the NVM SSD to pop up at a 30 degree angle, then gently pull it out.

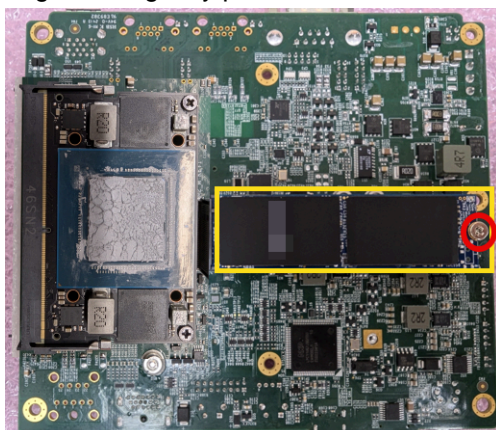

6. Locate the M.2 key M slot on the carrier board.

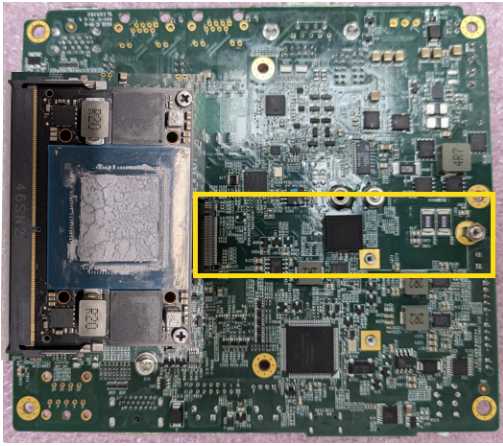

7. Align the notch on the SSD card with the tab in the slot and gently insert the SSD card at a 30 degree angle until it is fully embedded.
8. Press the SSD card down and fasten it to the mainboard with the M2.5x5L screw.

! Important:

Notice for System Reassembly:

- **Inspect the thermal pads:** Check whether the thermal pads on the mini-ITX thermal plate are damaged or broken. If replacement is required, contact SINTRONES® technical support or your sales representative.
- It is also recommended to replace the CPU thermal grease after detaching the carrier board from the thermal plate to maintain effective heat dissipation.
- **Align the mainboard correctly:** Position the IMB-600 carrier board in the correct orientation so that it aligns precisely with the designated area on the thermal plate.

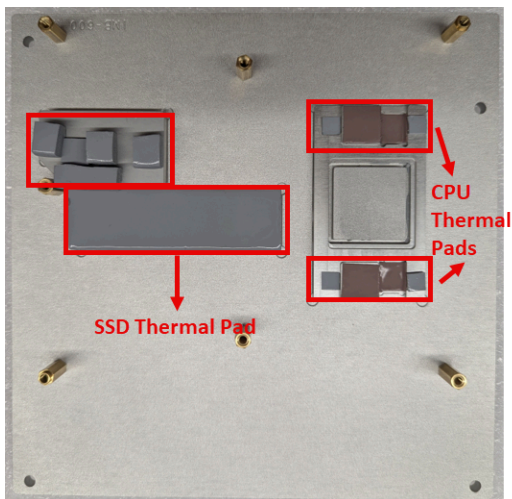

2.2.1.2. Installing an M.2 3042 or 3052 Module

1. Installing an M.2 3042 Key B LTE WWAN card (USB 3.2):

a. Locate the M.2 3042 Key B slot on the mainboard.

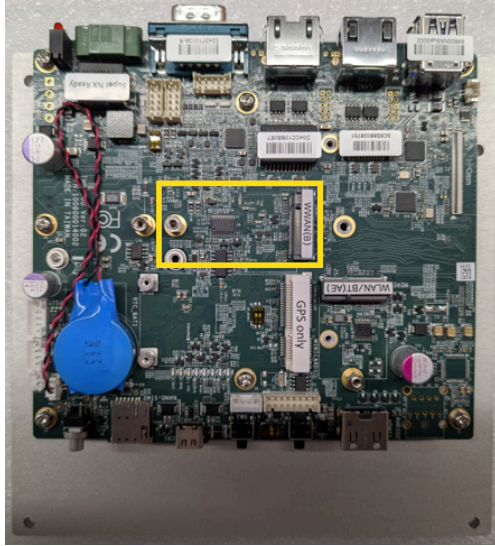

b. Move the standoff screw (H73D50) from location **H8** to **H9** as shown below:

Figure 2-2 Standoff Screw (H73D50)

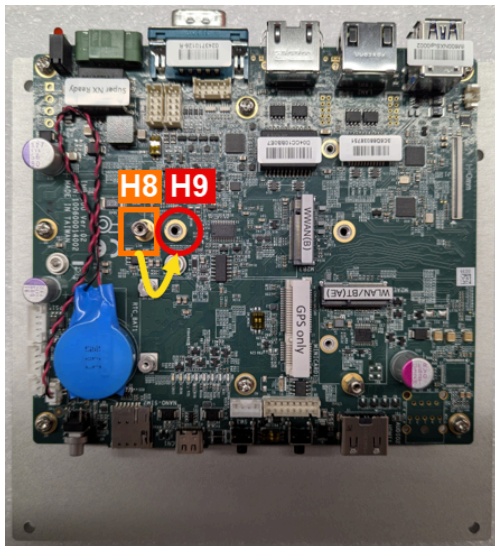

c. Get **two** hex standoff screws (H75D50) (on page 13) from the accessory bag.

d. Fasten the standoff screws (H75D50) to the mainboard as indicated in the figure below.

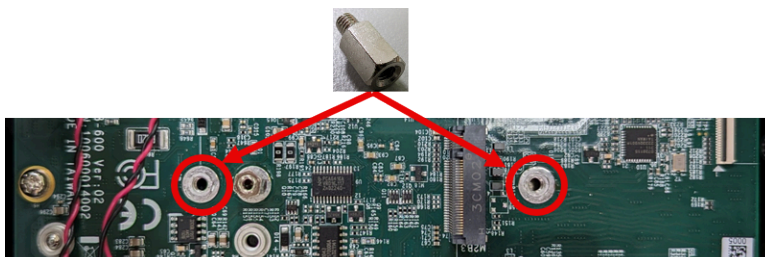

- e. Align the notch on the M.2 3042 WWAN module with the tab in the slot and gently insert it at a 30 degree angle until it is fully embedded, and then press it down.
- f. Secure the M.2 3042 WWAN module to the mainboard with the [M2.5x5L \(on page 14\)](#) screw provided in the package.
- g. To install a heatsink for the installed M.2 3042 module, go to [Installing a Heatsink for the M.2 3042 or 3052 Module \(on page 26\)](#) for the instructions.

2. Installing an M.2 3052 Key B 5G WWAN card (USB 3.2):

- a. Locate the M.2 3052 Key B slot on the mainboard.

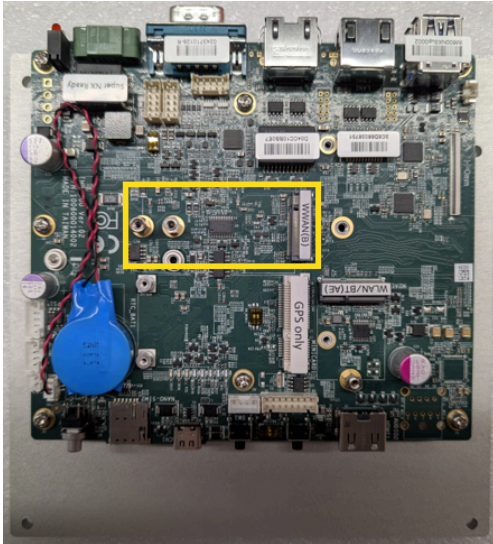

- b. Get **one** [hex standoff screw \(H75D50\) \(on page 13\)](#) from the accessory bag.
- c. Fasten the standoff screw (H75D50) to the mainboard as indicated in the figure below.

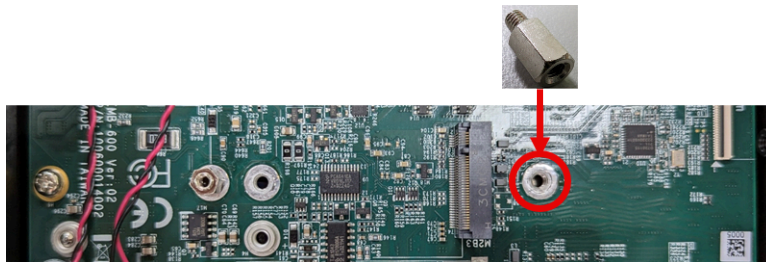

- d. Align the notch on the M.2 3052 WWAN module with the tab in the slot and gently insert it at a 30 degree angle until it is fully embedded, and then press it down.
- e. To install a heatsink for the installed M.2 3052 module, go to [Installing a Heatsink for the M.2 3042 or 3052 Module \(on page 26\)](#) for the instructions.

2.2.1.2.1. Installing a Heatsink for the M.2 3042 or 3052 Module

1. Before you begin, check the [Package Contents \(on page 13\)](#) and get the items below:
 - 1 x Thermal pad (27x34x1.5T mm)
 - 1 x M.2 WWAN heatsink Type 15
 - 1 x M2.5x10L screw
 - 1 x Standoff screw (H12D5)
2. Attach the thermal pad to the heatsink as shown below.

Thermal pad (27x34x1.5T mm)

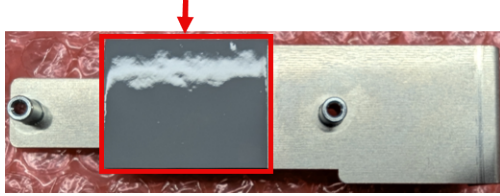

3. Align the two mounting holes on the heatsink with the mounting screw-holes on the mainboard, and then place the heatsink above the installed M.2 3042 or 3052 module.
4. Fasten the heatsink to the mainboard with the [M2.5x10L screw \(on page 13\)](#) and the [standoff screw \(H12D5\) \(on page 13\)](#).

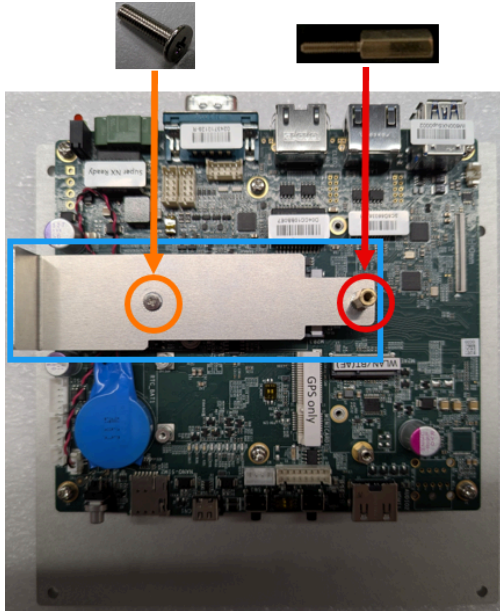

Note:

The M2.5x10L screw is also used to secure the M.2 3052 module to the mainboard.

5. After completing the installation of the M.2 3042 LTE or 3052 5G module, go to [Installing a Nano SIM Card \(on page 29\)](#) for how to install a SIM card.

2.2.1.3. Installing an M.2 2230 Module

1. Locate the M.2 2230 Key E slot on the mainboard.

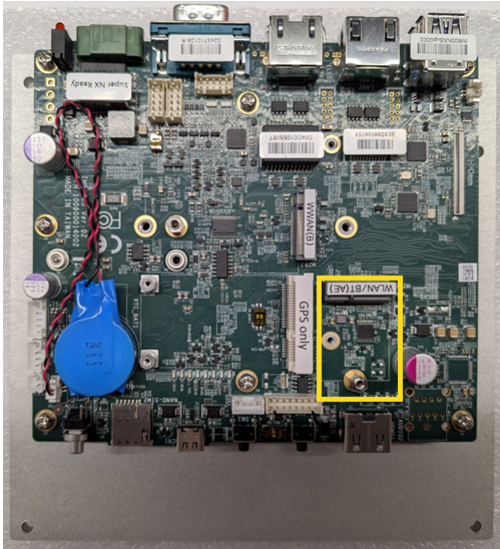

2. Align the notch on the expansion module with the tab in the slot and gently insert the module at a 30 degree angle until it is fully embedded, and then press it down.

**Note:**

Ensure you align the semicircular mounting hole at the center of the opposite edge on the module with the copper pillar bump when pressing the module down.

3. Secure the expansion module to the mainboard with the [M2.5x5L screw \(on page 14\)](#) provided in the package.

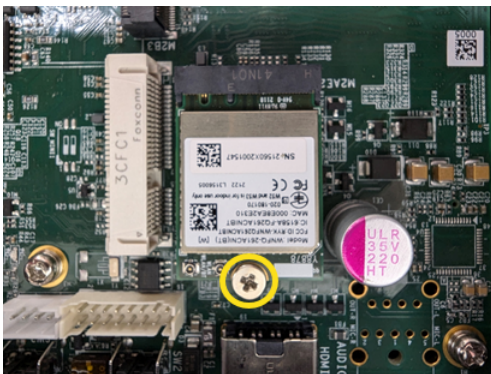

2.2.1.4. Installing an Mini PCIe Module

1. Locate the mini PCIe connector on the mainboard.

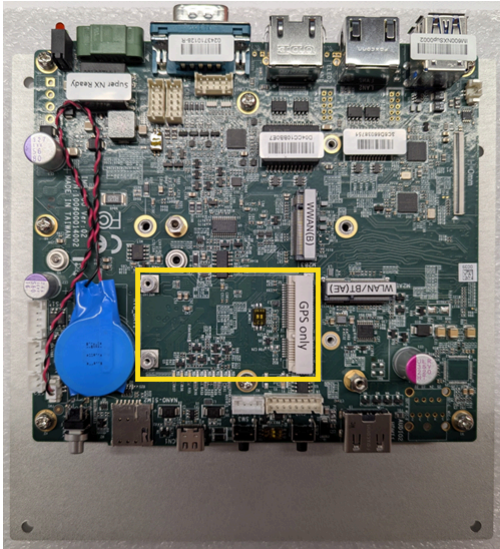

2. Align the notch on the mini PCIe card with the tab in the connector slot and gently insert the card at a 30 degree angle until it is fully embedded, and then press it down.
3. Secure the mini PCIe card to the mainboard with the [M2x5L screw\(s\)](#) ([on page 14](#)) provided in the package.

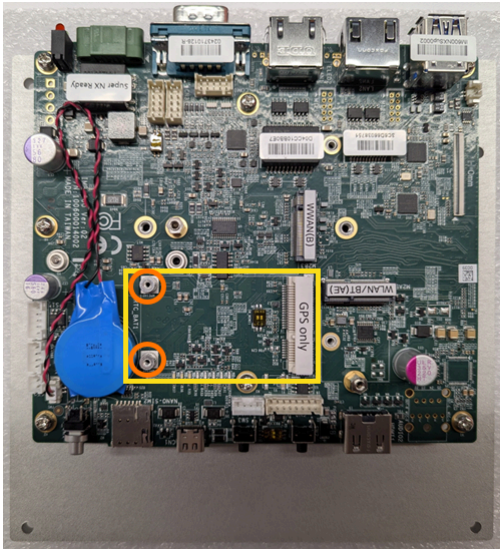

2.2.2. Installing a Nano SIM Card

1. Ensure the IMB-600 is powered off.
2. Locate the Nano SIM CARD slot on the IMB-600.

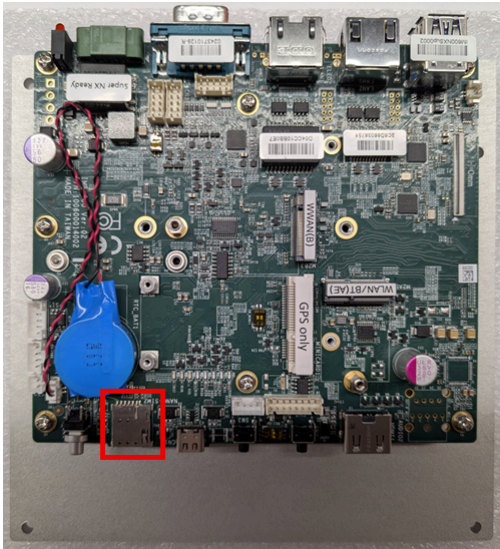

3. Insert the nano SIM card into the slot.
4. Use your fingernail or a small paperclip to press the card inwards until it locks in place.

**Note:**

To remove the SIM card, ensure you power off the system, and then use your fingernail or a small paperclip to push the card until it pops out.

2.2.3. Installing the GMSL-2 Deserializer Board

Installing the GMSL-2 deserializer board requires care and precision. It is recommended to consult SINTRONES® technical support for installation requirements.

In the following procedures, the **VDB100/101GDS4 PCBA** will be used to refer to the GMSL-2 deserializer board.

Before you begin, check the optional [VDB-100/101GDS4 Kit \(on page 13\)](#) purchased from SINTRONES®, which includes:

- VDB-100GDS4 or VDB-101GDS4 PCBA
- Accessory bags for the VDB-100/101GDS4 Kit

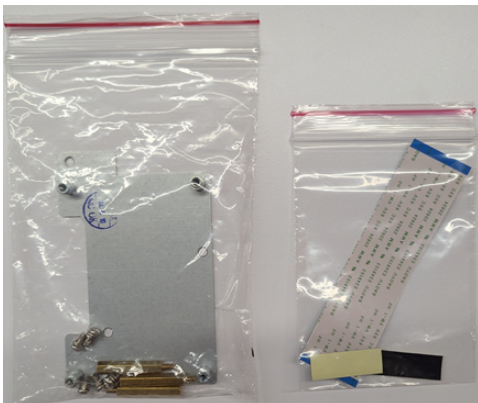

- FAKRA cable (used for connecting cameras only; not used in the installation process below)

1. Get the accessory bags for the VDB-100/101GDS4 kit.
2. If M.2 3042/3052 WWAN module expansion (with heatsink) is required, complete its installation before installing the VDB100/101GDS4 PCBA. See [Installing an M.2 3042 or 3052 Module \(on page 25\)](#) for detailed instructions.
3. Installation differs slightly depending on whether the M.2 3042/3052 WWAN module (with heatsink) is installed:
 - **M.2 3042/3052 WWAN module + heatsink installed:**
 - a. Remove **two** P3x6L screws from the mainboard. Place them aside for later use.

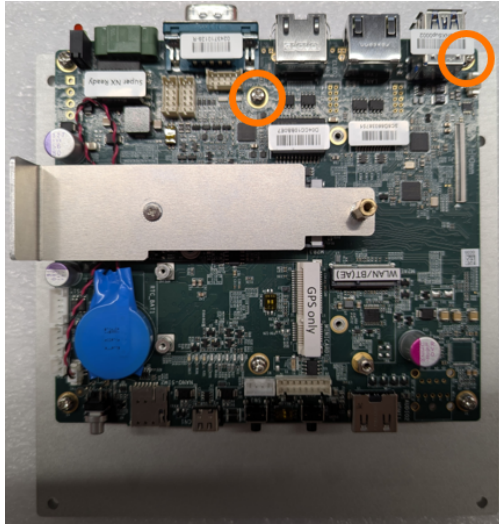
**Important:**

Keep the two P3x6L screws for reuse when fastening the VDB100/101GDS4 PCBA to its bracket in [Step 16 \(on page 35\)](#).

- b. Get **two** [standoff screws \(H26D5\) \(on page 15\)](#) and fasten them to the mainboard as indicated in the figure below.

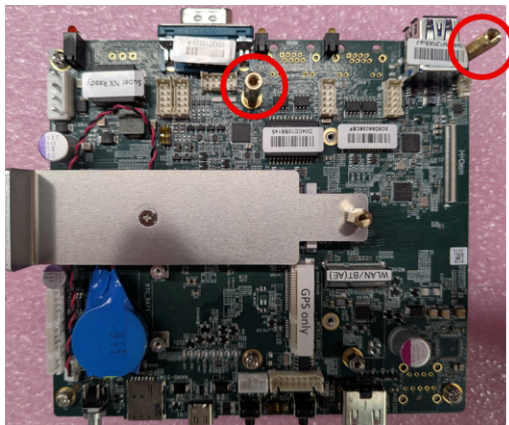

- **M.2 3042/3052 WWAN module NOT installed:**

- a. Remove **two** P3x6L screws from the mainboard. Place them aside for later use.

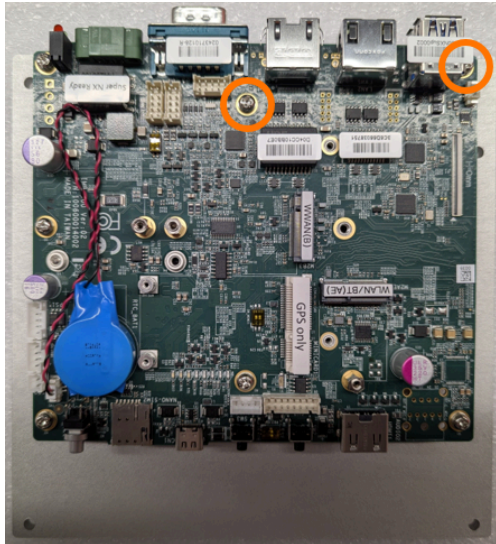

Important:

Keep the two P3x6L screws for reuse when fastening the VDB100/101GDS4 PCBA to its bracket in [Step 16 \(on page 35\)](#).

- b. Get **three** standoff screws (H26D5) ([on page 15](#)) and fasten them to the mainboard as indicated in the figure below.

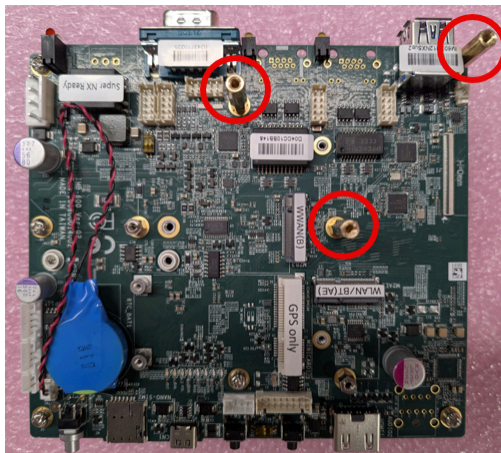

- 4. **Unlock the FFC Connector:** Locate the FFC connector on the mainboard and check if the locking clip is flipped up. If not, gently flip it up.

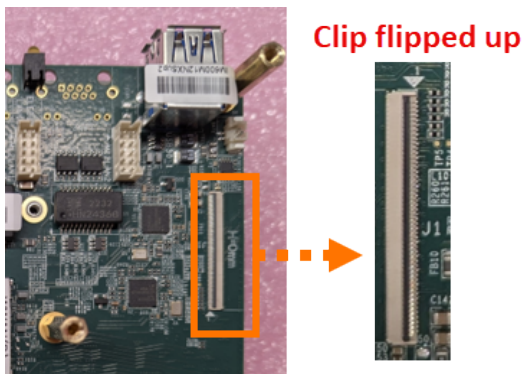

5. **Insert the FFC Cable:** With the text side facing up, insert the [FFC cable \(on page 15\)](#) straight into the FFC connector slot, not at an angle. Ensure it goes in evenly and fully to the end.



Important:

Do not bend, twist, or pull the FFC cable tightly, as this can damage the internal wires.

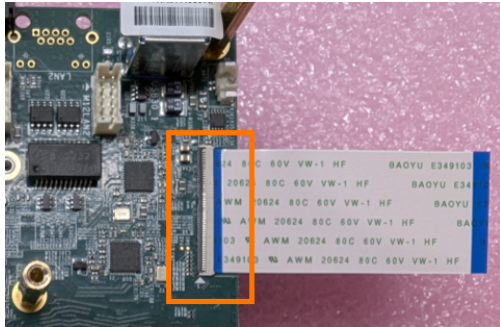

6. **Lock the FFC cable:** After the cable is fully inserted, gently flip the locking clip down to secure the connection.
7. **Verify:** Check that the cable is fully inserted and the locking clip is completely flipped down.
8. Attach the [adhesive tape \(on page 15\)](#) to the FFC connector. Ensure it does not extend beyond the edge of the locking clip.

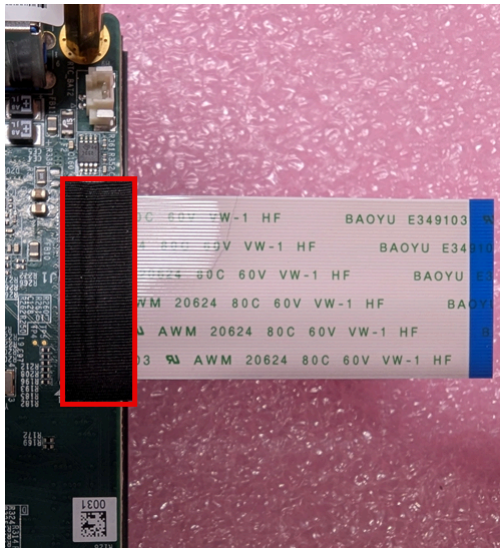

9. Get the [VDB-100/101GDS4 PCBA \(on page 15\)](#) from the kit.
10. Locate the FFC connector on the VDB100/101GDS4 PCBA and check if the locking clip is flipped up. If not, gently flip it up.

VDB-101GDS4

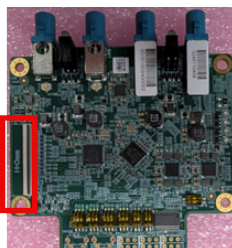

VDB-100GDS4

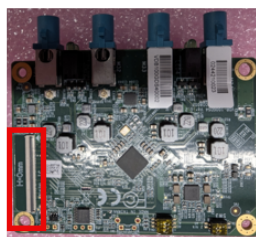

11. With the text side facing up, insert the other end of the FFC cable straight into the FFC connector slot on the VDB100/101GDS4 PCBA, not at an angle. Ensure it goes in evenly and fully to the end.



Important:

Do not bend, twist, or pull the FFC cable tightly, as this can damage the internal wires.

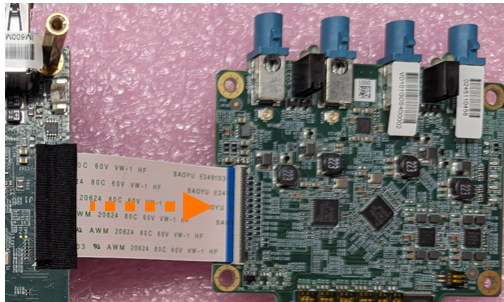

- 12. **Lock the FFC cable:** After the cable is fully inserted, gently flip the locking clip down to secure the connection.
- 13. **Verify:** Check that the cable is fully inserted and the locking clip is completely flipped down.
- 14. Attach the [adhesive tape](#) ([on page 15](#)) to the FFC connector. Ensure it does not extend beyond the edge of the locking clip.

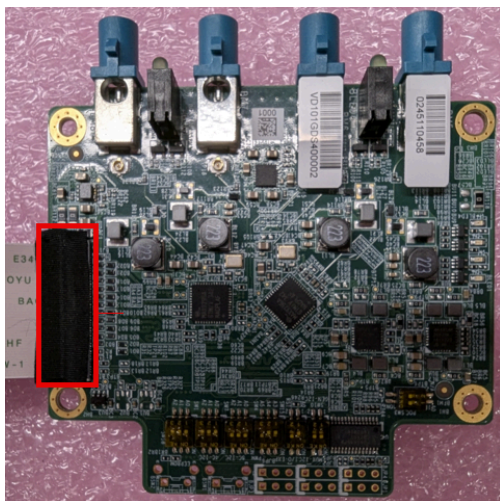

- 15. Fasten the [PCBA Bracket](#) ([on page 16](#)) to the mainboard with three [P3x6L screws](#) ([on page 15](#)).

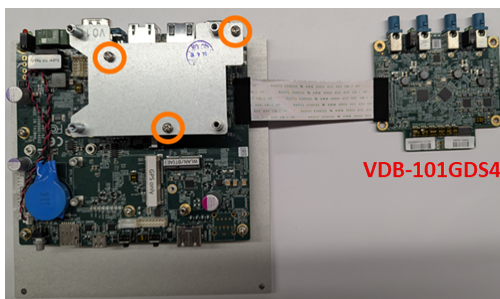

16. Fasten the VDB-100/101GDS4 PCBA to the mainboard with the [remaining two P3x6L screws from the accessory bag \(on page 15\)](#) and the [two P3x6L screws removed in Step 3 \(on page 31\)](#).

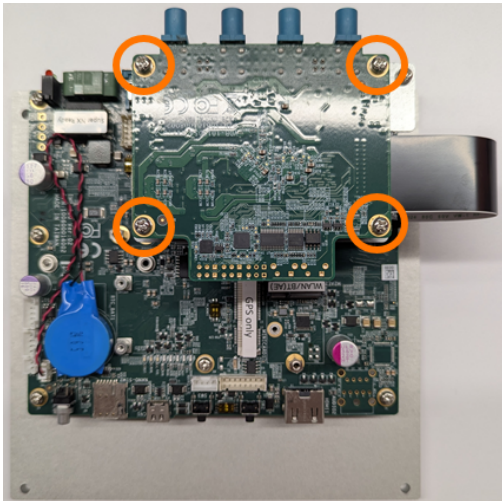

2.3. Booting the System

This section describes how to boot the system via an ignition switch or the power button.

2.3.1. Wiring the Terminal Block

This system supports a DC power input of **9V to 60V** through a 3-pin terminal block. Follow the steps below to connect the power wires.

1. Get the terminal block provided in the accessory package.
2. Prepare the wires for connecting the terminal block to a power supply.
3. Insert the **positive (+)** wire into the terminal marked "+" and the **negative (-)** wire into the terminal marked "-". See the following diagrams as the illustration of wiring an ignition switch to use in fields with or without an ignition system.

Figure 2-3 Fields WITH an Ignition System

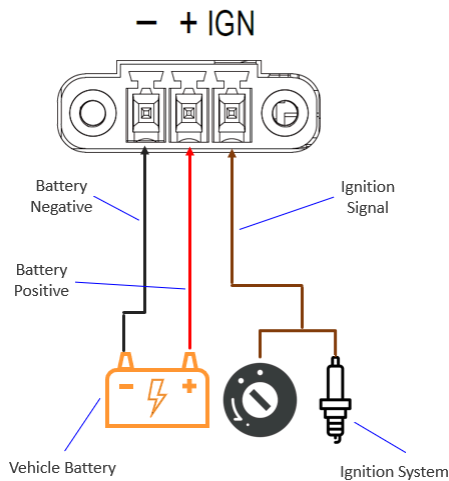
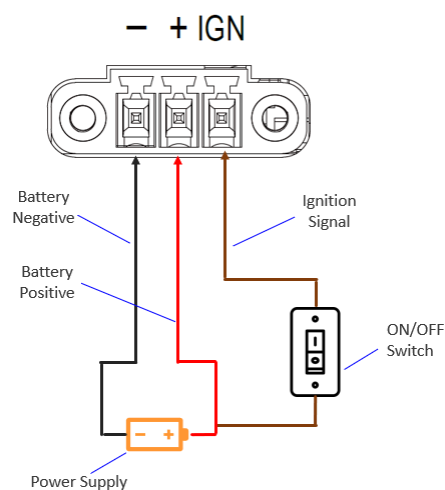

Figure 2-4 Fields WITHOUT an Ignition System



4. Tighten the screws on the terminal block to secure the wires firmly.
5. Plug the terminal block into the DC-IN port of the computer.
6. Connect the other ends of the wires to a stable DC power source within the supported voltage range.
7. Ensure the power source is switched off while wiring, then verify the connection before powering on the system to avoid damage.

2.3.2. Powering On the System by Ignition Switch

1. When the system is connected to a stable DC power source within the supported voltage range, turn on the ignition switch.
2. The system starts checking if there's any incoming ignition signal. It takes about **3 seconds** for the system to run the ignition control process.



Note:

SINTRONES® provides ignition power management that monitors the ignition signal and controls the system boot process to avoid potential risk of downtime or damages to the connected devices and system.

3. After the ignition control process is complete, the system will boot up.

Figure 2-5 Turning On System By Ignition Switch

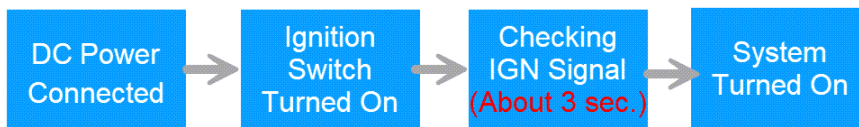

2.3.3. Powering On the System by Button

1. When the system is connected to a stable DC power source within the supported voltage range, press the power button.
2. The **Power Button** turns to blue light when the system boots up.

Figure 2-6 Turning On the System

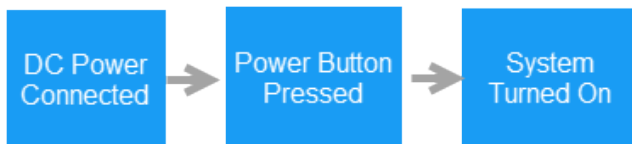

2.4. Initial Login

For product shipped **before May 1, 2026**, use the following default credentials for initial login:

- **Username:** `sintrones` (enter in lowercase)
- **Password:** `24332747`



Important:

For security reasons, change both the username and password immediately after your first login.

To fulfill cybersecurity requirements, **effective May 1, 2026**, default credentials will no longer be provided. Users must create a unique username and password during their initial login.

3. External I/O Ports

Topics in this chapter include:

- [Front I/O \(on page 39\)](#)
- [Rear I/O \(on page 41\)](#)
- [Specifications of External I/O Ports \(on page 43\)](#)

3.1. Front I/O

This section lists the front I/O components and corresponding descriptions.

Figure 3-1 Front View of IMB-600 Carrier Board + GMSL-2 Deserializer Board

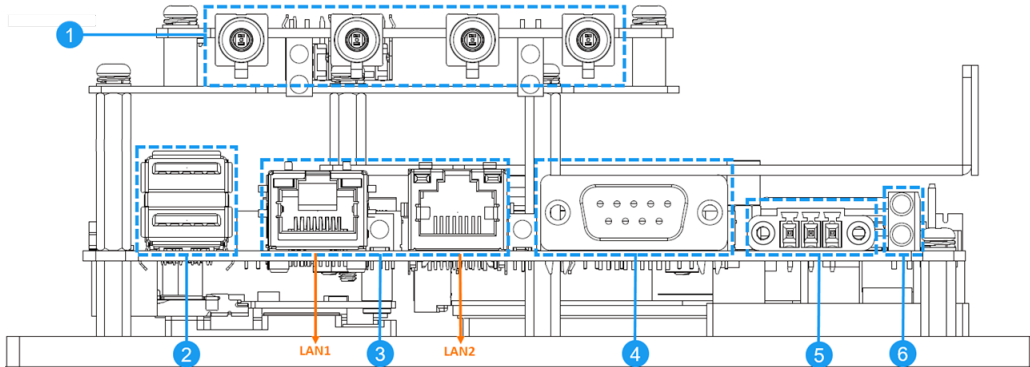



Table 3-1 Front I/O

Item	I/O Interface	Description	Specification
1	Camera Ports	4 x FAKRA-Z connectors for GMSL-2 cameras  Note: Available only on the GMSL-2 deserializ- er board (VDB-100/101GDS4 DEV KIT), which is sold separately.	-
2	USB (10Gbps) Ports	2 x USB 3.2 Gen 2, 5V / 900mA  Note: Two USB Type-A ports share 10Gbps bandwidth.	USB 3.2 Port (on page 43)
3	LAN Ports	<ul style="list-style-type: none"> • LAN 1: GbE (10/100/1000BASE-T) • LAN 2: 2.5 GbE (10/100/1000/2500BASE-T) • RJ-45 ports 	-
4	COM Port	<ul style="list-style-type: none"> • Supports RS-232/422/485 interfaces • Programmable via software configuration • DB9 connector 	COM Port (on page 43)
5	DC Input	<ul style="list-style-type: none"> • Input voltage range: DC 9-60V • 3-pin terminal block 	DC-IN Port (3-Pin Terminal Block) (on page 44)
6	LED Indicators	Upper LED:	-

Item	I/O Interface	Description	Specification
		<ul style="list-style-type: none"> • ON: Backup battery in use • OFF: External power supply active or no backup battery installed 	
		<p>Lower LED:</p> <ul style="list-style-type: none"> • ON: Ignition enabled • OFF: Ignition disabled 	-

3.2. Rear I/O

This section provides the rear panel view and the description of the associated I/O interface.

Figure 3-2 Rear Panel of IMB-600 Carrier Board + GMSL-2 Deserializer

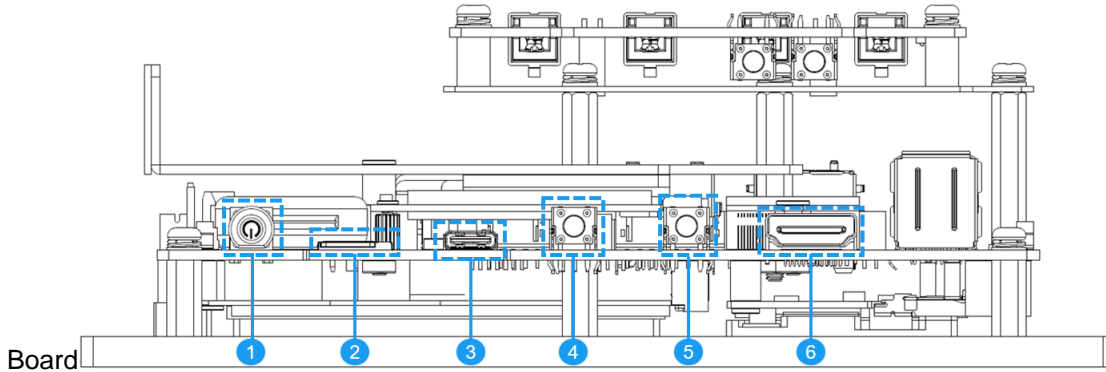





Table 3-2 Rear I/O

Item	I/O Interface	Description	Specification
1	Power Button	System power status: <ul style="list-style-type: none"> • Red light: Standby mode • Blue light: System turned on 	-
2	Nano SIM Card Slot	Supports a nano SIM card <p> Note: Ensure you power off the system before installing or removing the SIM card.</p>	-
3	USB (Device) Port	Used for system recovery when connected to a host computer containing certain JetPack BSP image via a USB Type-C cable. See BSP Flashing and System Configuration (on page 61) for the detailed instructions. <p> Note: This USB port is used only for system recovery. It does not support power or other kinds of data transfer.</p>	USB Type-C Port (on page 44)
4	Recovery Button	Used for system recovery. <p> Note: The recovery button works only when the USB (Device) port (as described above) is connected to a host computer.</p>	-
5	Reset Button	Used for system reboot	-

Item	I/O Interface	Description	Specification
6	HDMI® Port	Supports HDMI® Type-A connector	HDMI® Port (on page 45)

3.3. Specifications of External I/O Ports

This section provides drawings and pin definitions of the external I/O ports.

3.3.1. USB 3.2 Port

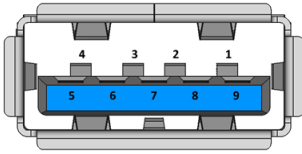

Table 3-3 Pin Definition of USB 3.2 Port

Pin	Signal
1	VBUS
2	D-
3	D+
4	GND
5	StdA_SSRX-
6	StdA_SSRX+
7	GND_DRAIN
8	StdA_SSTX-
9	StdA_SSTX+

3.3.2. COM Port

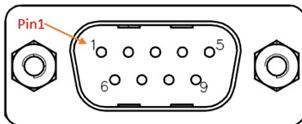

Table 3-4 Pin Definition of COM Port (D-Sub 9 (Male))

Pin	D-Sub 9 (Male)		
	RS-232	RS-422	RS-485
1	DCD#	TXD-	Data-
2	RXD	TXD+	Data+
3	TXD	RXD+	NC
4	DTR#	RXD-	NC
5	GND	GND	GND
6	DSR#	NC	NC
7	RTS#	NC	NC
8	CTS#	NC	NC
9	RI#	NC	NC

3.3.3. DC-IN Port (3-Pin Terminal Block)

DC-IN 9V ~ 60V
IGN + -

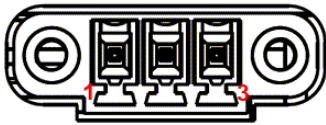

Table 3-5 Pin Definition of DC-IN Port (3-Pin Terminal Block)

Pin	Signal
1	Ignition
2	V+
3	V-

3.3.4. USB Type-C Port



Table 3-6 Pin Definition of USB Type-C Port

Pin	Signal	Pin	Signal
A1	GND	B12	GND
A2	NC	B11	NC
A3	NC	B10	NC
A4	NC	B9	NC
A5	NC	B8	NC
A6	Dp1	B7	Dn2
A7	Dn1	B6	Dp2
A8	NC	B5	NC
A9	NC	B4	NC
A10	NC	B3	NC
A11	NC	B2	NC
A12	GND	B1	GND

3.3.5. HDMI® Port

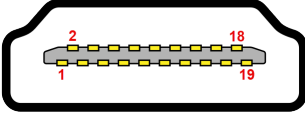

Table 3-7 Pin Definition of HDMI® Port

Pin	Signal	Pin	Signal
1	HDMI_DATA2_P	2	GND
3	HDMI_DATA2_N	4	HDMI_DATA1_P
5	GND	6	HDMI_DATA1_N
7	HDMI_DATA0_P	8	GND
9	HDMI_DATA0_N	10	HDMI_CLK_P
11	GND	12	HDMI_CLK_N
13	NCCEC	14	NC
15	HDMI_SCL	16	HDMI_SDA
17	GND	18	V5P_S_HDMI
19	HDMI_HPDET		

4. Expansion

This chapter provides more details about the internal slots or connectors used for expansion purpose.

Topics in this chapter include:

- [Top View of Mainboard \(on page 47\)](#)
- [Bottom View of Mainboard \(on page 48\)](#)
- [Specifications of Expansion Slots/Connectors \(on page 49\)](#)

4.1. Top View of Mainboard

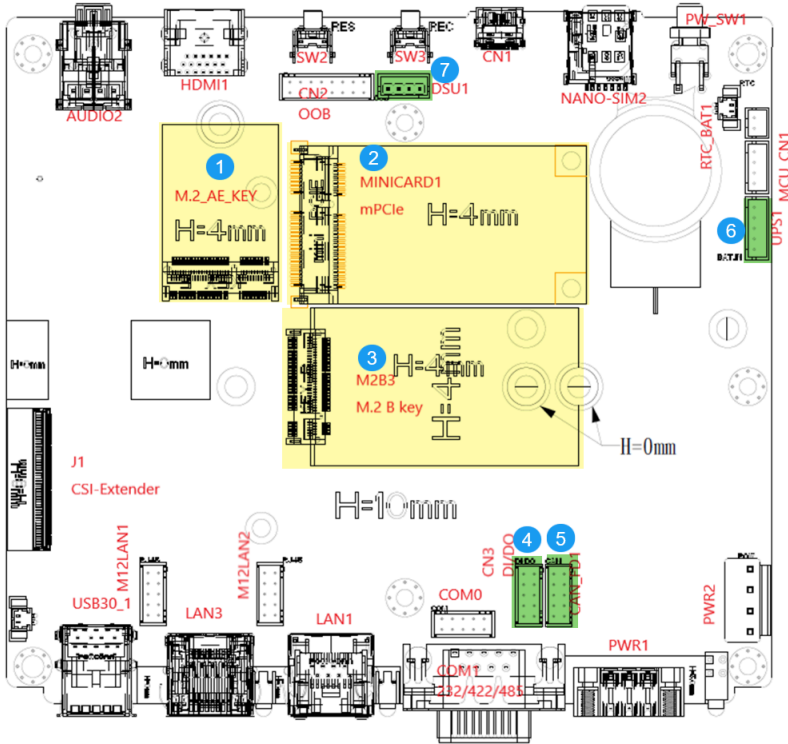

Item	Internal Connector	Description	Specification
1	M.2_AE_KEY	The M.2 2230 Key E slot used for installing an expansion module such as a WLAN or Bluetooth module.	M.2 Key E Slot (on page 50)
2	MINICARD1	The mini PCIe full-size slot used for installing one mini PCIe card supporting USB 2.0 interface.	Mini PCIe Connector (on page 53)
3	M2B3	The M.2 3042/3052 Key B slot used for installing an expansion module such as a WWAN module.	M.2 Key B Slot (on page 49)
4	DI/DO	The DIO JST connector used for connecting the DIO cable.	DIO JST Connector (on page 55)
5	CAN_FD1	The CAN JST connector used for connecting the CAN cable.	CAN Bus JST Connector (on page 55)
6	UPS1	The UPS JST connector used for connecting the backup battery.	-
7	DSU1	The DSU JST connector used for monitoring system status and collecting debug logs	DSU JST Connector (on page 56)

4.2. Bottom View of Mainboard

The pre-installed NVIDIA® Jetson system on modules (SoM) and NVMe SSD are located on the bottom side of the mainboard. It is suggested to consult SINTRONES technical support for expansion requirements for Jetson SoM or an NVMe SSD.

! Important:

- DO NOT remove the pre-installed SSD, or install an empty one without preparing any backup image in advance.
- A minimum of 256GB space is recommended on the flash drive for NVMe storage.

Figure 4-1 Bottom View of Mainboard

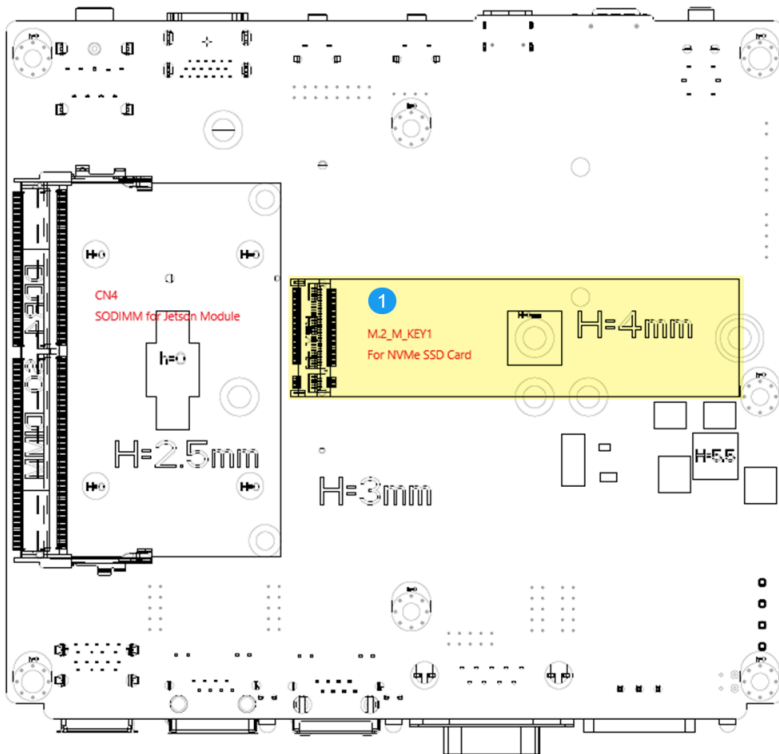

Item	Internal Connector	Description	Specification
1	M2M1	M.2 2280 Key M slot used for installing an NVMe SSD	M.2 Key M Slot (<i>on page 52</i>)

4.3. Specifications of Expansion Slots/Connectors

This section provides drawings and pin definitions about the slots or connectors used to install expansion modules.

4.3.1. M.2 Key B Slot

M.2 Key B Slot	Description
Size	NGFF 3042 / 3052 / 75 Pin
Type	M.2 Key B H:8.5mm
Location	See Top View of Mainboard (on page 47) for the information.
Drawing	

Table 4-1 Pin Definition of M.2 Key B Slot

Pin	Signal	Pin	Signal
1	NC	2	3VSB
3	GND	4	3VSB
5	GND	6	Reserve
7	M2B_USB1_DP	8	Reserve
9	M2B_USB1_DN	10	Reserve
11	GND	12	KEY
13	KEY	14	KEY
15	KEY	16	KEY
17	KEY	18	KEY
19	KEY	20	NC
21	NC	22	NC
23	WWAN_WAKE	24	NC
25	M2B1DPR	26	Reserve
27	GND	28	NC
29	M2B_USB3.2_RXN	30	M2UIM_RST_A
31	M2B_USB3.2_RXP	32	M2UIM_CLK_A
33	GND	34	M2UIM_DAT_A

Pin	Signal	Pin	Signal
35	M2B_USB3.2_TXN	36	M2UIM_PWR_A
37	M2B_USB3.2_TXP	38	NC
39	GND	40	NC
41	NC	42	NC
43	NC	44	M2B_ALERN
45	GND	46	NC
47	NC	48	NC
49	NC	50	DEV_3V3RST#
51	GND	52	Reserve
53	NC	54	WWAN_WAKE
55	NC	56	NC
57	GND	58	NC
59	NC	60	NC
61	NC	62	NC
63	NC	64	NC
65	NC	66	NC
67	M2B1RST2	68	NC
69	CONFIG_1	70	3VSB
71	GND	72	3VSB
73	GND	74	3VSB
75	NC		

4.3.2. M.2 Key E Slot

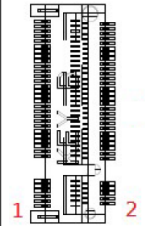
M.2 Key E Slot	Description
Size	NGFF 2230 / 75 Pin
Type	M.2 Key E H:8.5mm
Location	See Top View of Mainboard (on page 47) for the information.
Drawing	

Table 4-2 Pin Definition of M.2 Key E Slot

Pin	Signal	Pin	Signal
1	GND	2	V3P3_A
3	HUBA_USB_2P	4	V3P3_A
5	HUBA_USB_2N	6	NC
7	GND	8	NC
9	NC	10	NC
11	NC	12	NC
13	NC	14	NC
15	NC	16	NC
17	NC	18	NC
19	NC	20	BT_UART_WAKE_B
21	NC	22	UART0_RXD
23	NC	24	KEY
25	KEY	26	KEY
27	KEY	28	KEY
29	KEY	30	KEY
31	KEY	32	UART0_TXD
33	GND	34	UART0_CTS
35	PCIE1_TX0_P	36	UART0_RTS
37	PCIE1_TX0_N	38	NC
39	GND	40	NC
41	PCIE1_RX0_P	42	NC
43	PCIE1_RX0_N	44	NC
45	GND	46	NC
47	PCIE1_CLK_P	48	NC
49	PCIE1_CLK_N	50	BT_OSC_32KHZ
51	GND	52	PCIE1_RST
53	PCIE1_CLKREQ	54	M2E_WIFI_DIS2(BT)
55	PCIE_WAKE	56	M2E_WIFI_DIS1(WIFI)
57	GND	58	JS_I2C2_SDA
59	NC	60	JS_I2C2_SCL
61	NC	62	M2E_ALERT
63	GND	64	NC
65	NC	66	NC

Pin	Signal	Pin	Signal
67	NC	68	NC
69	GND	70	WIFI_WAKE
71	NC	72	V3P3_A
73	NC	74	V3P3_A
75	GND		

4.3.3. M.2 Key M Slot

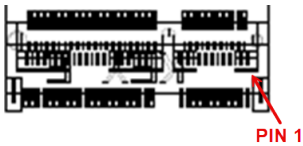
M.2 Key M Slot	Description
Size	NGFF 2280 / 75 Pin
Type	M.2 Key M H:8.5mm
Location	See Bottom View of Mainboard (on page 48) for the information.
Drawing	

Table 4-3 Pin Definition of M.2 Key M Slot

Pin	Signal	Pin	Signal
1	GND	2	3VSB
3	GND	4	3VSB
5	PCIE0_RX3_N	6	NC
7	PCIE0_RX3_P	8	NC
9	GND	10	NC
11	PCIE0_TX3_N	12	3VSB
13	PCIE0_TX3_P	14	3VSB
15	GND	16	3VSB
17	PCIE0_RX2_N	18	3VSB
19	PCIE0_RX2_P	20	NC
21	GND	22	NC
23	PCIE0_TX2_N	24	NC
25	PCIE0_TX2_P	26	NC
27	GND	28	NC

Pin	Signal	Pin	Signal
29	PCIE0_RX1_N	30	NC
31	PCIE0_RX1_P	32	NC
33	GND	34	NC
35	PCIE0_TX1_N	36	NC
37	PCIE0_TX1_P	38	NC
39	GND	40	JS_I2C2_SCL
41	PCIE0_RX0_N	42	JS_I2C2_SDA
43	PCIE0_RX0_P	44	M2M_ALERT
45	GND	46	NC
47	PCIE0_TX0_N	48	NC
49	PCIE0_TX0_P	50	PCIE0_RST
51	GND	52	PCIE0_CLKREQ
53	PCIE0_CLK_N	54	PCIE_WAKE
55	PCIE0_CLK_P	56	NC
57	GND	58	NC
59	KEY	60	KEY
61	KEY	62	KEY
63	KEY	64	KEY
65	KEY	66	KEY
67	NC	68	NC
69	NGFF3_PEDET	70	3VSB
71	GND	72	3VSB
73	GND	74	3VSB
75	GND		

4.3.4. Mini PCIe Connector

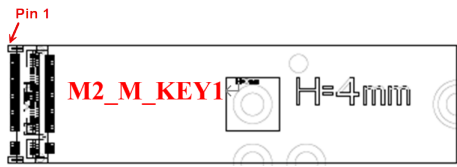
Mini PCIe Connector	Description
Size	2 x 26 / 52 Pin
Type	MINI PCI-E CON H:9.2mm
Location	See Top View of Mainboard (on page 47) for the information.

Mini PCIe Connector	Description
Drawing	

Table 4-4 Pin Definition of Mini PCIe Connector (MINICARD1 & 2)

Pin	Signal	Pin	Signal
1	WAKE#	2	3V3_VSB
3	NC	4	GND
5	NC	6	1V5(Reserve)
7	NC	8	NC
9	GND	10	NC
11	NC	12	NC
13	NC	14	NC
15	GND	16	NC
17	NC	18	GND
19	NC	20	W_DIS
21	GND	22	RESET#
23	NC	24	3V3_VSB
25	NC	26	GND
27	GND	28	1V5(Reserve)
29	GND	30	I2C_SCL
31	NC	32	I2C_SDA
33	NC	34	GND
35	GND	36	USB_DN
37	GND	38	USB_DP
39	3V3_VSB	40	GND
41	3V3_VSB	42	NC
43	GND	44	NC
45	NC	46	NC
47	NC	48	1V5(Reserve)

Pin	Signal	Pin	Signal
49	NC	50	GND
51	NC	52	3V3_VSB

4.3.5. DIO JST Connector

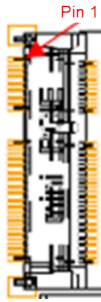
DIO JST Connector	Description
Size	2 x 5 / 10 Pin
Type	JST-2.0mm-M-180
Location	See Top View of Mainboard (on page 47) for the information.
Drawing	

Table 4-5 Pin Definition

Pin	Signal	Signal	Signal
1	DI_1	2	DI_2
3	DI_3	4	DI_4
5	DO1	6	DO2
7	DO3	8	DO4
9	GND	10	GND_CASS

4.3.6. CAN Bus JST Connector

CAN Bus JST Connector	Description
Size	2 x 5 / 10 Pin
Type	JST-2.0mm-M-180
Location	See Top View of Mainboard (on page 47) for the information.
Drawing	

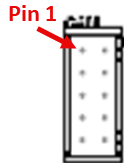
Table 4-6 Pin Definition

Pin	Signal	Signal	Signal
1	CAN0_CANH	2	CAN0_CANL
3	CAN_GND	4	CAN_GND
5	NC	6	NC
7	CAN_GND	8	CAN_GND
9	NC	10	NC

4.3.7. DSU JST Connector

DSU JST Connector	Description
Size	1 x 4 / 4 Pin
Type	JST-2.0mm-M-180
Location	See Top View of Mainboard (on page 47) for the information.
Drawing	

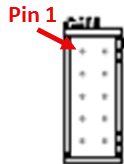
Table 4-7 Pin Definition

Pin	Signal
1	Power
2	JETSON_UART2_TX
3	JETSON_UART2_RX
4	GND

The DSU JST connector is used to monitor the system status and collect debug logs via UART protocol by advanced developers. There's no need to use this connector under normal operation.

To retrieve UART logs, connect a host computer to the system with a USB-UART or RS232-UART converter cable (not included in the package), and then configure the UART settings on the host computer as shown below:

- Baud rate: 115,200bps
- Voltage: DC 3.3V
- Data bits: 8
- Parity bit: 0
- Flow control: No

5. Software

Topics in this chapter include:

- [Customizing BSP Kernel Source Build \(on page 58\)](#)
- [System Configuration \(on page 65\)](#)

5.1. Customizing BSP Kernel Source Build

This chapter describes how to modify and package the BSP kernel source build provided by SINTRONES® and flash the modified BSP image to the IMB-600 carrier board.

5.1.1. Prerequisites for Host Environment Setup

A **host computer with Internet access** and some accessories are required to set up a host environment for the IMB-600 carrier board. Before you begin, check the following list as the hardware and system requirements for the host computer and accessories.

Host Computer:

- Memory size: 32GB or above
- Storage space: 256GB or above
- Recommended OS: Ubuntu 20.04/22.04 LTS (x64 version)

Accessories:

- A USB Type-C cable
- An HDMI cable
- A monitor supporting HDMI input

5.1.2. Host Environment Setup

Follow the procedures below to prepare a host computer for creating, customizing (if necessary), and flashing the board support packages (BSPs) to the IMB-600 carrier board.

1. Connect the host computer to the Internet.
2. Open the terminal window.
3. Enter the following commands to **install the required dependencies**.

```
sudo apt update
```

```
sudo apt install -y abootimg bzip2 libxml2-utils nfs-kernel-server sshpass
```

4. **Download and save the required tools and source packages** for the host environment setup, which include container runtimes (e.g., Docker), kernel source code, and BSPs. The tools and packages can be downloaded from SINTRONES® website or contact our sales representative for assistance.
5. Follow the steps below to **extract the downloaded tools and source packages**:

- a. **Navigate to the directory** where `Docker.zip`, `sources.zip`, `Linux_for_Tegra_[DATE_TIME].tbz2` and their checksums are located.

For example: `cd ~/nvidia`



Note:

Replace `~/nvidia` with the actual path where your files are stored.

- b. Run the following commands to **verify the integrity of the files** using their SHA-256 checksums:

```
Docker: sha256sum -c Docker.zip.sha256
```

```
Kernel source code: sha256sum -c sources.zip.sha256
```

```
BSP: sha256sum -c Linux_for_Tegra_[DATE_TIME].tbz2.sha256
```

c. Run the following commands to **extract the specified files**:

Docker: `sudo unzip Docker.zip`

Kernel source code: `sudo unzip sources.zip`

BSP: `sudo tar xvjpf Linux_for_Tegra_[DATE_TIME].tbz2`

5.1.3. Docker Setup and Container Access

Follow the steps below to install the Docker setup files and access the container from the host computer.

1. Navigate to the directory containing the extracted Docker setup files.

```
cd Docker
```

2. Run the setup script.

```
sudo ./setup.sh
```

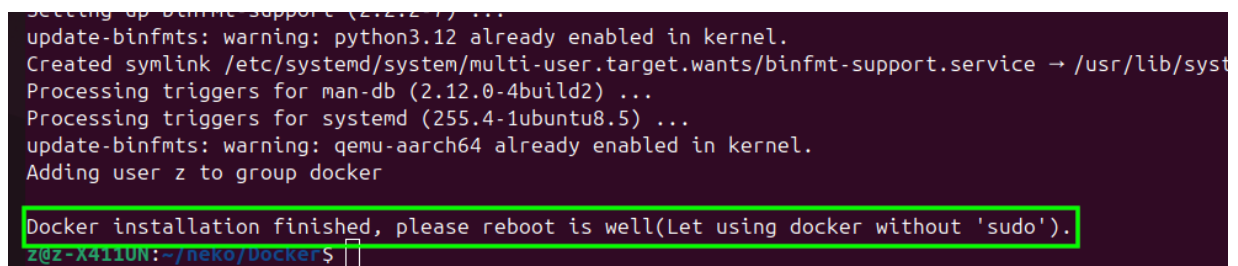

```
Setting up binfmt-support (2.2.2-7) ...
update-binfmts: warning: python3.12 already enabled in kernel.
Created symlink /etc/systemd/system/multi-user.target.wants/binfmt-support.service → /usr/lib/systemd/system/binfmt-support.service
Processing triggers for man-db (2.12.0-4build2) ...
Processing triggers for systemd (255.4-1ubuntu8.5) ...
update-binfmts: warning: qemu-aarch64 already enabled in kernel.
Adding user z to group docker

Docker installation finished, please reboot is well(Let using docker without 'sudo').
z@z-X411UN:~/neko/Docker$
```

3. Reboot the host computer to apply the configuration changes made by the setup script.
4. **Create a data volume container** to enable persistent linkage between host directories and the container.

```
docker run -d -v ${HOME}:/home/${whoami} -v /var/run/avahi-daemon/socket:/var/run/avahi-daemon/socket --name [DATA_VOLUME_NAME] ubuntu:[VERSION]
```



Tip:

You can mount multiple host directories by inserting additional `-v` flags before `--name`:

```
-v [HOST_DIRECTORY]:[CONTAINER_DIRECTORY]
```

Example (for Ubuntu 20.04):

```
docker run -d -v ${HOME}:/home/${whoami} -v /var/run/avahi-daemon/socket:/var/run/avahi-daemon/socket --name storage ubuntu:20.04
```



```
z@z-X411UN:~/neko/Docker$ docker run -d -v ${HOME}:/home/${whoami} -v /var/run/avahi-daemon/socket:/var/run/avahi-daemon/socket --name storage ubuntu:20.04
Unable to find image 'ubuntu:20.04' locally
20.04: Pulling from library/ubuntu
13b7e930469f: Pull complete
Digest: sha256:8feb4d8ca5354def3d8fce243717141ce31e2c428701f6682bd2fafa15388214
Status: Downloaded newer image for ubuntu:20.04
15e75e5b7cc732c8792b20334951198e866ada7d0710Fca826541f5123304df9
z@z-X411UN:~/neko/Docker$
```

5. **Build the Docker image:** Use the following command to build your Docker image with user-specific arguments:

```
docker build --build-arg _USER=${whoami} --build-arg _GROUP=${whoami} --build-arg UID=$(id -u) --build-arg GID=$(id -g) --build-arg CCACHE_GRP_GID=$(cut -d: -f3 < <(getent group docker)) -t [IMAGE_TAG]:[TAG_VERSION] -f [DOCKER_FILE] .
```



Important:

Be sure to include the final period (.) in the command.

Example with `--no-cache` option:

```
docker build --no-cache --build-arg _USER=$(whoami) --build-arg _GROUP=$(whoami) --build-arg
UID=$(id -u) --build-arg GID=$(id -g) --build-arg CCACHE_GRP_GID=$(cut -d: -f3 < <(getent group
docker)) -t nvidia_jetson -f Dockerfile .
```

6. Create and access a Docker container: Use the following command to launch a privileged Docker container with persistent volume linkage and custom host mounts.

```
docker run -it --group-add ccache --hostname "DOCKER_${hostname}" --privileged --volumes-from
[DATA_VOLUME_NAME] --name [CONTAINER_NAME] [IMAGE_TAG]:[VERSION]
```



Tip:

You can mount multiple host directories by inserting additional `-v` flags before `[IMAGE_TAG]:[VERSION]`:

```
-v [HOST_DIRECTORY]:[CONTAINER_DIRECTORY]
```

Example:

```
docker run -it --group-add ccache --hostname "DOCKER_${hostname}" --privileged --volumes-from
storage --name nvidia_jetson nvidia_jetson
```

5.1.4. Building BSP Kernel Source Code

After accessing the Docker container, follow the steps below to build a BSP kernel source code within the container.

1. Navigate to the directory containing the extracted [kernel source code \(on page 59\)](#) files.

```
cd ~/nvidia/sources
```



Note:

Replace `~/nvidia` with the actual path where your files are stored.

2. Customize the source files if necessary.
3. Run the script to build a BSP kernel source code.

```
sudo ./st_build.sh
```

The BSP kernel source code has been successfully built.

```
e/nvidia/t23x/nv-public/overlay/tegra234-p3737-camera-eCAM130A-overlay.dtbo /mnt/build/kernel-devicetree/generic-
ric-dts//hardware/nvidia/t23x/nv-public/overlay/tegra234-p3737-camera-inx390-overlay.dtbo /mnt/build/kernel-devic
ree/generic-dts//hardware/nvidia/t23x/nv-public/overlay/tegra234-p3737-camera-p3762-a00-1Hawk-overlay.dtbo /mnt/b
d/kernel-devicetree/generic-dts//hardware/nvidia/t23x/nv-public/overlay/tegra234-p3737-camera-p3762-a00-3Hawk-30w
verlay.dtbo /mnt/build/kernel-devicetree/generic-dts//hardware/nvidia/t23x/nv-public/overlay/tegra234-p3737-camer
762-a00-overlay.dtbo /mnt/build/kernel-devicetree/generic-dts//hardware/nvidia/t23x/nv-public/overlay/tegra234-p3
a-p3768-inx219-C.dtbo /mnt/build/kernel-devicetree/generic-dts//hardware/nvidia/t23x/nv-public/overlay/tegra234-p
p3768-inx219-inx477.dtbo /mnt/build/kernel-devicetree/generic-dts//hardware/nvidia/t23x/nv-public/overlay/tegra23
ra-p3768-inx477-A.dtbo /mnt/build/kernel-devicetree/generic-dts/dtbs/ ; \
fi
if [ -d /mnt/build/kernel-devicetree/generic-dts/hardware/ ] ; then \
    rm -rf /mnt/build/kernel-devicetree/generic-dts/hardware/ ; \
fi
make[1]: Leaving directory '/mnt/build'
=====
DTBs compiled successfully.
=====
make: Leaving directory '/mnt/build'
Modules compiled successfully.
Build finished
```

**Important:**

If the kernel source or Device Tree Source (DTS) has been changed, be sure to manually move the kernel modules or Device Tree Blob (DTB) to the appropriate directories within `Linux_for_Tegra_[DATE_TIME]`.

This ensures the changes are reflected on the target device during flashing.

5.1.5. Setting the IMB-600 in Recovery Mode

Follow the procedures to set the IMB-600 in recovery mode and connect it to the host computer.

1. Ensure the IMB-600 is powered off.
2. Locate the USB Type-C port on the rear side of the IMB-600.

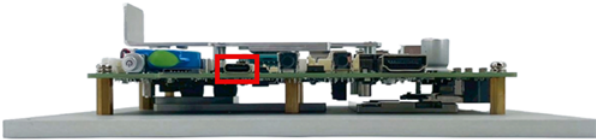

3. Plug one end of a USB Type-C cable into the port, and then plug the other end of the cable to the host computer.
4. Locate the **RECOVERY** button on the rear side of the IMB-600.

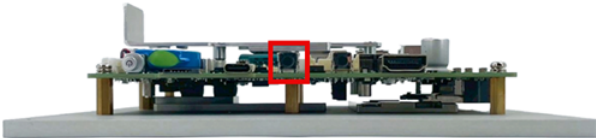

5. **Press and hold** the **RECOVERY** button, at the same time, **connect the system to a power source** and enable ignition if any.

**Note:**

If the system is not connected with any ignition system, simply press the power button.

6. After powering on the system, hold the **RECOVERY** button for **more than 5 seconds**, and then release it.

5.1.6. BSP Flashing and System Configuration

Follow the steps below to flash the BSP to the IMB-600 carrier board.

1. Ensure the IMB-600 carrier board is connected via a USB-C cable and set in recovery mode. See [Setting the IMB-600 in Recovery Mode \(on page 61\)](#) for more details.

**Note:**

It is recommended to use a high-quality USB-C cable to ensure a successful flashing process. If a low-quality cable is used, the flashing process may fail.

2. On the host computer, navigate to the directory containing the extracted BSP files.

```
cd Linux_for_Tegra_[DATE_TIME]
```

3. Run the script to start the flashing.

```
sudo ./ibox600_nx_flash.sh
```



Note:

This may take a few minutes to complete.

- The system will reboot after the BSP is successfully flashed.

```

Writing /mnt/internal/qspi_bootblob_ver.txt (189 bytes) into /dev/mtd0:66912256
Copied 189 bytes from /mnt/internal/qspi_bootblob_ver.txt to address 0x03fd0000 in flash
Writing qspi_bootblob_ver.txt (partition: A_VER) into /dev/mtd0
Shai checksum matched for /mnt/internal/qspi_bootblob_ver.txt
Writing /mnt/internal/qspi_bootblob_ver.txt (189 bytes) into /dev/mtd0:66977792
Copied 189 bytes from /mnt/internal/qspi_bootblob_ver.txt to address 0x03ff0000 in flash
Writing gpt_secondary_3_0.bin (partition: secondary_gpt) into /dev/mtd0
Shai checksum matched for /mnt/internal/gpt_secondary_3_0.bin
Writing /mnt/internal/gpt_secondary_3_0.bin (16896 bytes) into /dev/mtd0:67091948
Copied 16896 bytes from /mnt/internal/gpt_secondary_3_0.bin to address 0x03ffb000 in flash
[ 234]: l4t_flash_from_kernel: Successfully flash the qspi
[ 234]: l4t_flash_from_kernel: Flashing success
[ 234]: l4t_flash_from_kernel: The device size indicated in the partition layout xml is smaller than the actual size. This utility will try to fix the GPT.
Flash is successful
Reboot device
CREATING UP...
Log is saved to Linux_for_Tegra/initrdlog/flash_1-7_0_20250708-172819.log

```

- After the system reboot, the **System Configuration** wizard appears to guide users to complete the initial basic settings for the Linux for Tegra (L4T) platform.
- Select **I accept the terms of these licenses** and then select **Continue**.

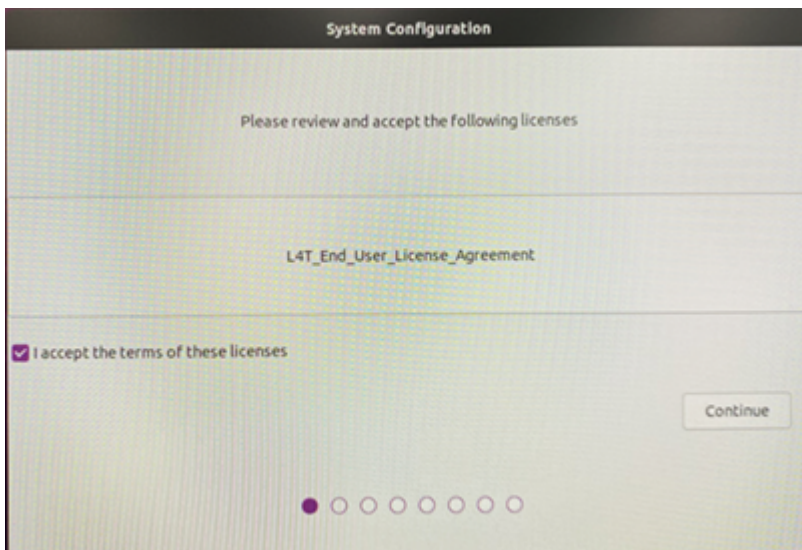

- Select the preferred language setting and then select **Continue**.

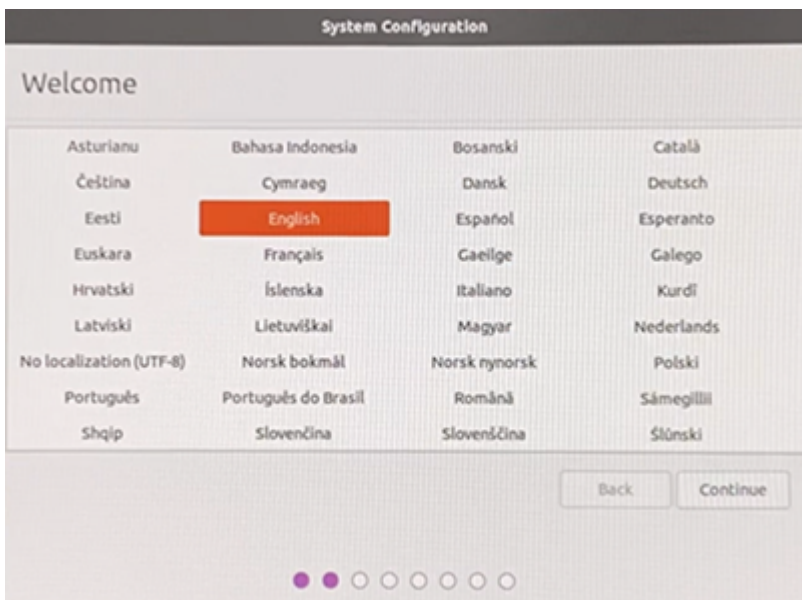

8. Select the preferred keyboard layout and then select **Continue**.

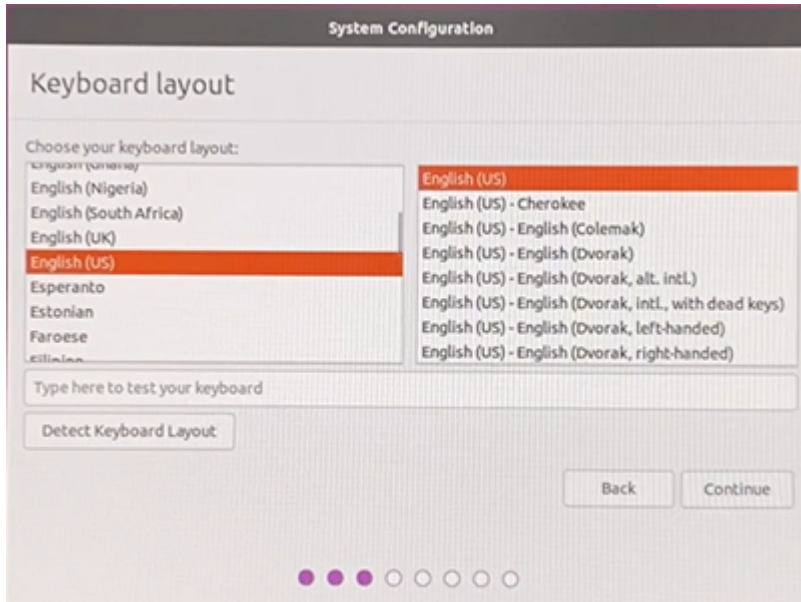

9. Select your location and then select **Continue**.

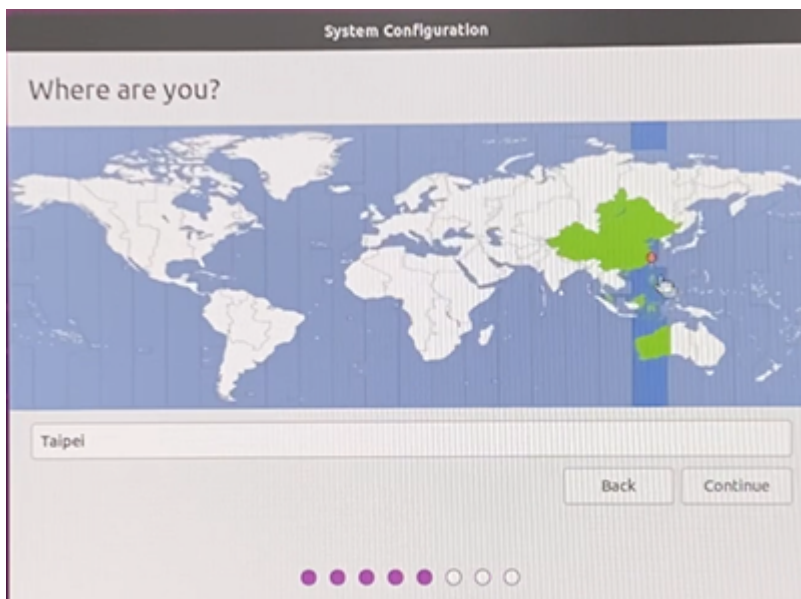

10. Specify the credentials such as a username and a password to create a user account, and then select **Continue** to proceed to next step.



Note:

It is suggested to select **Require my password to log in** for security reasons.

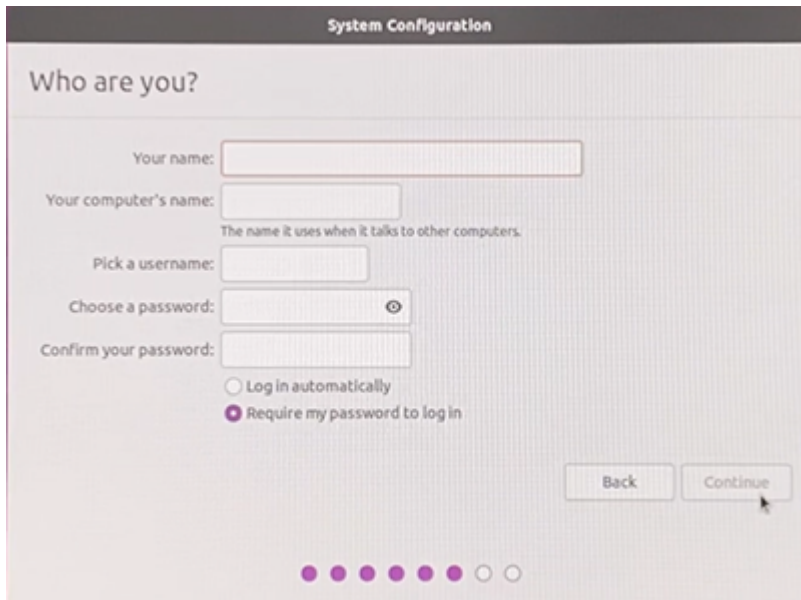

11. Choose **Install Chromium Browser** or **Do not install...** based on your needs, and then select **Continue**.
12. The system starts running the specified configuration and will reboot to complete the system configuration.

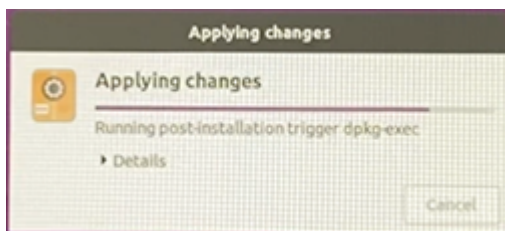
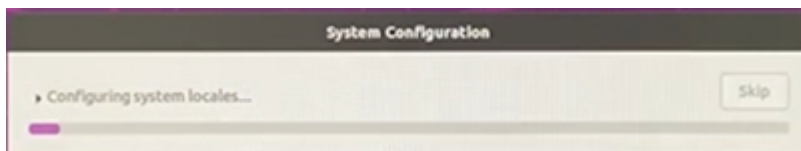

13. The **NVIDIA** logo appears and then the restored system will enter the welcome screen, ready to use now.

5.2. System Configuration

This section provides procedures about how to install the GMSL camera driver as well as summarizes commands available for configuring smart power management, COM (RS-232/422/485), CAN FD, and DI/DO interface controllers.

5.2.1. Smart Power Management Settings

This section summarizes the commands available for configuring the Smart Power Management function.

5.2.1.1. Overview of Smart Power Management Commands

The general formats of the Smart Power Management commands are as follows:

`i2cget -y -f <i2c_num> <device_addr> <reg_addr>`: Used to **check** the current state of certain functionality.

`i2cset -f -y <i2c_num> <device_addr> <reg_addr> <value>`: Used to **change or save** the settings of certain functionality.

5.2.1.2. Smart Power Management Commands

See the following tables as the available commands for Smart Power Management.

Table 5-1 Checking IGN/UPS Status

Command	Value	Description	Outcome
<code>i2cget -y -f 1 0x4a 0x12</code>	-	Check the ignition (IGN) status	<ul style="list-style-type: none"> • <code>0x00</code>: Ignition turned off • <code>0x01</code>: Ignition turned on
<code>i2cget -y -f 1 0x4a 0x10</code>	-	Check the UPS backup battery status	<ul style="list-style-type: none"> • <code>0x07</code>: UPS mode

Table 5-2 Checking and Setting Ignition Power On Delay Time

Command	Value	Description	Outcome
<code>i2cget -y -f 1 0x4a 0x60</code>	-	Check the ignition power on delay time by seconds	If the delay time is set as 3 seconds, the output will be <code>0x03</code>
<code>i2cset -f -y 1 0x4a 0x60</code>	For example: <code>0x03</code>	Set the ignition power on delay time by seconds	For example, if you enter <code>i2cset -f -y 1 0x4a 0x60 0x03</code> , and then save the setting (on page 67) , the system will wait for 3 seconds to power on after the ignition is turned on.
<code>i2cget -y -f 1 0x4a 0x61</code>	-	Check the ignition power on delay time by minutes	If the delay time is set as 2 minutes, the output will be <code>0x02</code>

Command	Value	Description	Outcome
<code>i2cset -f -y 1 0x4a 0x61</code>	For example: 0x02	Set the ignition power on delay time by minutes	For example, if you enter <code>i2cset -f -y 1 0x4a 0x61 0x02</code> , and then save the setting (on page 67) , the system will wait for 2 minutes to power on after the ignition is turned on.
<code>i2cget -y -f 1 0x4a 0x62</code>	-	Check the ignition power on delay time by hours	If the delay time is set as 1 hour, the output will be 0x01
<code>i2cset -f -y 1 0x4a 0x62</code>	For example: 0x01	Set the ignition power on delay time by hours	For example, if you enter <code>i2cset -f -y 1 0x4a 0x62 0x01</code> , and then save the setting (on page 67) , the system will wait for 1 hour to power on after the ignition is turned on.

Table 5-3 Checking and Setting Ignition Power Off Delay Time

Command	Value	Description	Outcome
<code>i2cget -y -f 1 0x4a 0x66</code>	-	Check the ignition power off delay time by seconds	If the delay time is set as 3 seconds, the output will be 0x03
<code>i2cset -f -y 1 0x4a 0x66</code>	For example: 0x03	Set the ignition power off delay time by seconds	For example, if you enter <code>i2cset -f -y 1 0x4a 0x66 0x03</code> , and then save the setting (on page 67) , the system will wait for 3 seconds to power off after the ignition is turned off.
<code>i2cget -y -f 1 0x4a 0x67</code>	-	Check the ignition power off delay time by minutes	If the delay time is set as 2 minutes, the output will be 0x02
<code>i2cset -f -y 1 0x4a 0x67</code>	For example: 0x02	Set the ignition power off delay time by minutes	For example, if you enter <code>i2cset -f -y 1 0x4a 0x67 0x02</code> , and then save the setting (on page 67) , the system will wait for 2 minutes to power off after the ignition is turned off.

Command	Value	Description	Outcome
<code>i2cget -y -f 1 0x4a 0x68</code>	-	Check the ignition power off delay time by hours	If the delay time is set as 1 hour, the output will be <code>0x01</code>
<code>i2cset -f -y 1 0x4a 0x68</code>	For example: <code>0x01</code>	Set the ignition power off delay time by hours	For example, if you enter <code>i2cset -f -y 1 0x4a 0x68 0x01</code> , and then save the setting (on page 67) , the system will wait for 1 hour to power off after the ignition is turned off.

Table 5-4 Saving the Setting

Command	Description	Outcome
<code>i2cset -f -y 1 0x4a 0x28 0x02</code>	Save the setting.	<p>The specified setting will be saved.</p> <p> Important: Ensure you enter <code>i2cset -f -y 1 0x4a 0x28 0x02</code> to save and allow the system to execute the specified setting.</p>

5.2.2. Commands for COM Port (RS-232/422/485 Configuration)

The name of the COM port: ttyTHS1

See the following tables as the available commands list for the COM port.

Table 5-5 Running RS-232/422/485 Test Program

Command	Description
<code>rs232a-demo</code>	Run the RS-232 test program
<code>rs422a-demo</code>	Run the RS-422 test program
<code>rs485a-demo</code>	Run the RS-485 test program

Table 5-6 Switching between RS-232/422/485

Command	Outcome	Description
<code>sudo rs232_set</code>	RS232 Mode Set	Enable the RS-232 mode
<code>sudo rs422_set</code>	RS422 Mode Set	Enable the RS-422 mode
<code>sudo rs485_set</code>	RS485 Mode Set	Enable the RS-485 mode

Table 5-7 Checking the Status

Command	Outcome	Description
<code>i2cget -f -y 1 0x4a 0x3c</code>	<ul style="list-style-type: none"> • 0x09 rs232 • 0x1b rs422 • 0x12 rs485 	Check which mode (RS-232/422/485) is enabled.

5.2.3. CAN FD Configuration

The name of the CAN FD port: can0

See the following table as the available commands list for the CAN FD port.

Table 5-8 Initialization & Setup

Command	Description	Outcome
<code>sudo can_set</code>	Enable the CAN bus mode	CAN Bus set completed
<code>sudo ip link set down can0</code>	Disable the transmission function of the CAN bus	N/A
<code>sudo ip link set can0 type can bitrate 1000000 dbitrate 2000000 fd on</code>	Set the standard bit rate for the CAN bus as 1 Mbps and the data phase bit rate for CAN FD (Flexible Data Rate) as 2 Mbps. Enable CAN FD for faster transmission rate and larger data payloads (up to 64 bytes per frame).	N/A
<code>sudo ip link set up can0</code>	Enable the transmission function of the CAN bus	N/A

Table 5-9 Data Reception

Command	Description	Outcome
<code>candump can0 &</code>	Receive data	N/A

Table 5-10 Data Transmission

Command	Description	Outcome
<code>cansend can0 123#abcdabcd</code>	Send data	N/A

5.2.4. DIO Configuration

The system supports 4 channels of programmable digital input (DI) and digital output (DO), which can be configured to communicate or exchange data with the connected peripheral devices.



Note:

The DIO pins will be reset to default settings after a cold boot.

The general formats of the DIO commands are as follows:

`i2cget -f -y <i2c_num> <device_addr> <reg_addr>`: Used to **check** the current state of certain DI or DO channel.

`i2cset -f -y <i2c_num> <device_addr> <reg_addr> <value>`: Used to **change or save** the settings of certain DI or DO channel.

See the following as the DO data register table:

Table 5-11 DO Data Register – 0x31

Bit	Pin	Value
3	DO_4	Low: 0 High: 1
2	DO_3	
1	DO_2	
0	DO_1	

5.2.4.1. DIO Commands

See the following table as the available commands list for the DIO port.

Table 5-12 Checking Digital Input (DI) Status

Command	Value	Description
<code>i2cget -f -y 1 0x4A 0x30</code>	N/A	Get the state of all the digital input pins

Table 5-13 Examples of Configuring Digital Outputs (DO)

Command	Value	Description
<code>i2cset -f -y 1 0x4A 0x31 <value></code>	<code>0xf</code>	Set DO1 ~ DO4 as High (1111)
	<code>0x0</code>	Set DO1 ~ DO4 as Low (0000)
	<code>0x1</code>	Set DO1 as High (0001: DO1 = 1)

Command	Value	Description
	0x2	Set DO2 as High (0010: DO2 = 1)
	0x4	Set DO3 as High (0100: DO3 = 1)
	0x8	Set DO4 as High (1000: DO4 = 1)

5.2.5. (Optional) Setting the GMSL Camera

This section describes how to install the GMSL camera driver and configure associated settings.

See the following steps:

1. Before connecting GMSL cameras, ensure the system is powered off.
2. Connect the GMSL cameras to the camera ports via the FAKRA-Z cables.



Important:

Connect only one type of cameras at a time. Different camera types cannot be mixed because the system does not support running multiple camera drivers simultaneously.

3. Connect the system to an HDMI monitor, a keyboard, and a mouse.
4. Boot the system and check if the green LEDs of the connected cameras light on.



Note:

See [Booting the System \(on page 36\)](#) for how to boot the system via an ignition switch or the power button.

5. Open the terminal window.
6. Run the following commands to launch the camera selection utility.

```
sudo camera_driver_install_switch
```

7. Choose the camera you want to initialize, and then click **Select**.

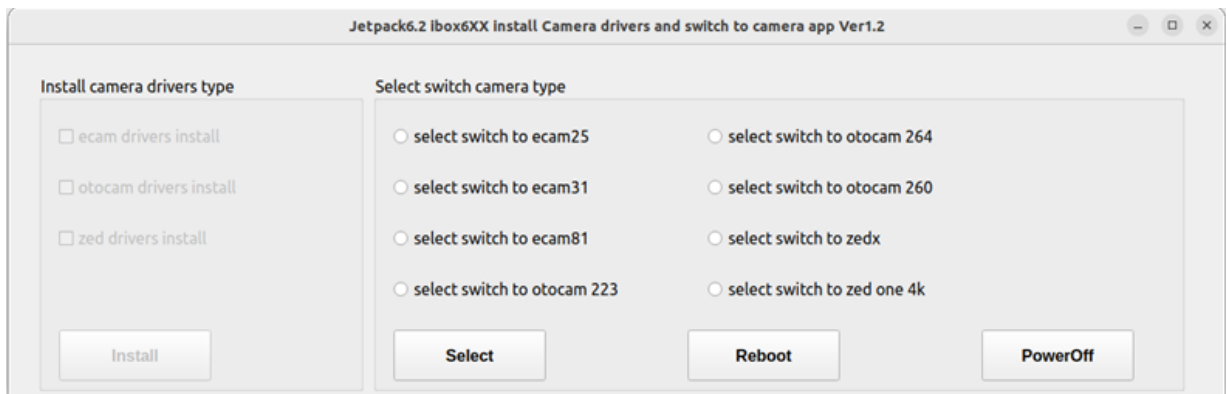

8. Click **Reboot** to reboot the system.
9. After the system reboot, enter the following command to verify whether the connected cameras have been successfully initialized.

```
ls /dev/vi*
```

For example, if you connect three cameras to the system via CAM1, CAM2, and CAM3 ports, the corresponding device names shall appear in the command output.



Port names and corresponding device names shown in CLI:

- CAM1: video0
- CAM2: video1

- CAM3: video2
- CAM4: video3